

Grune Post - wings

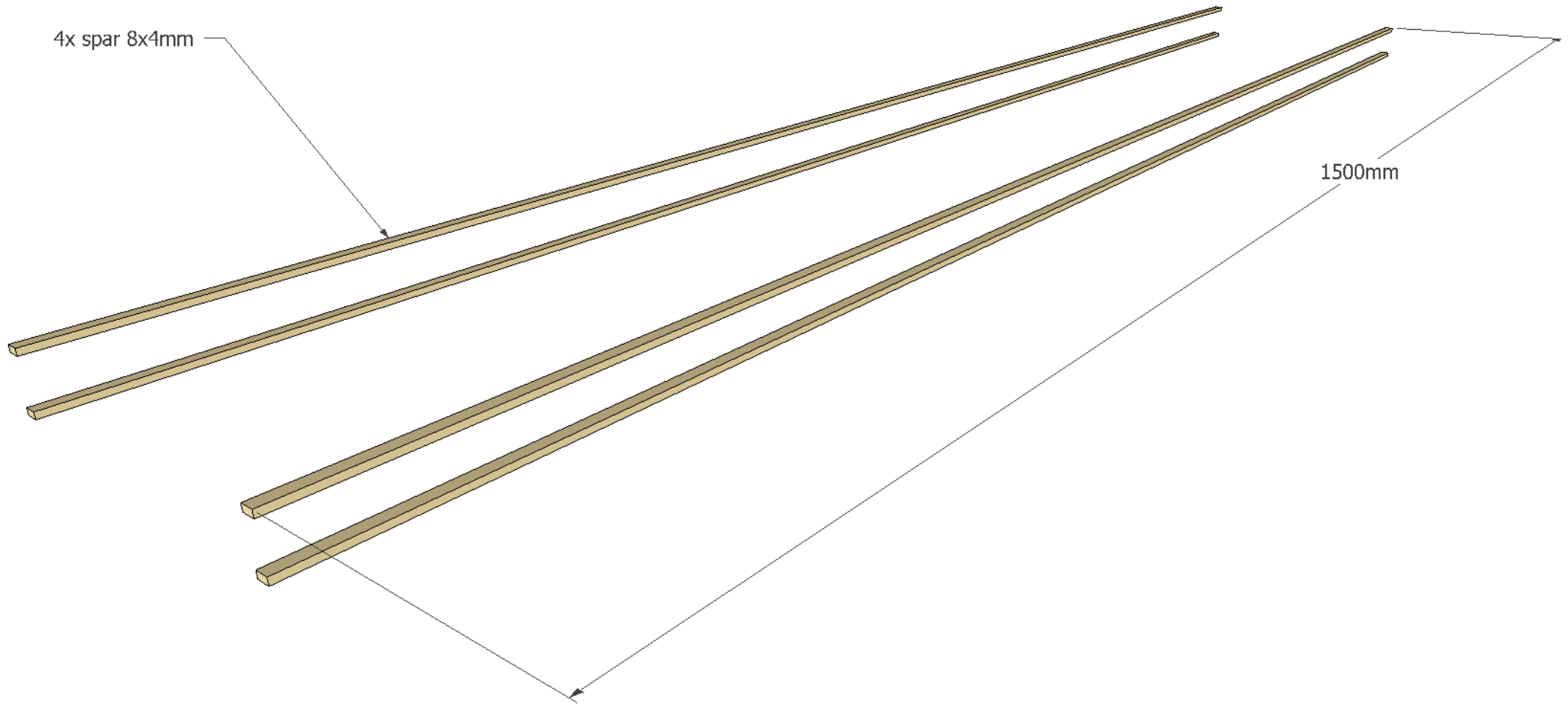

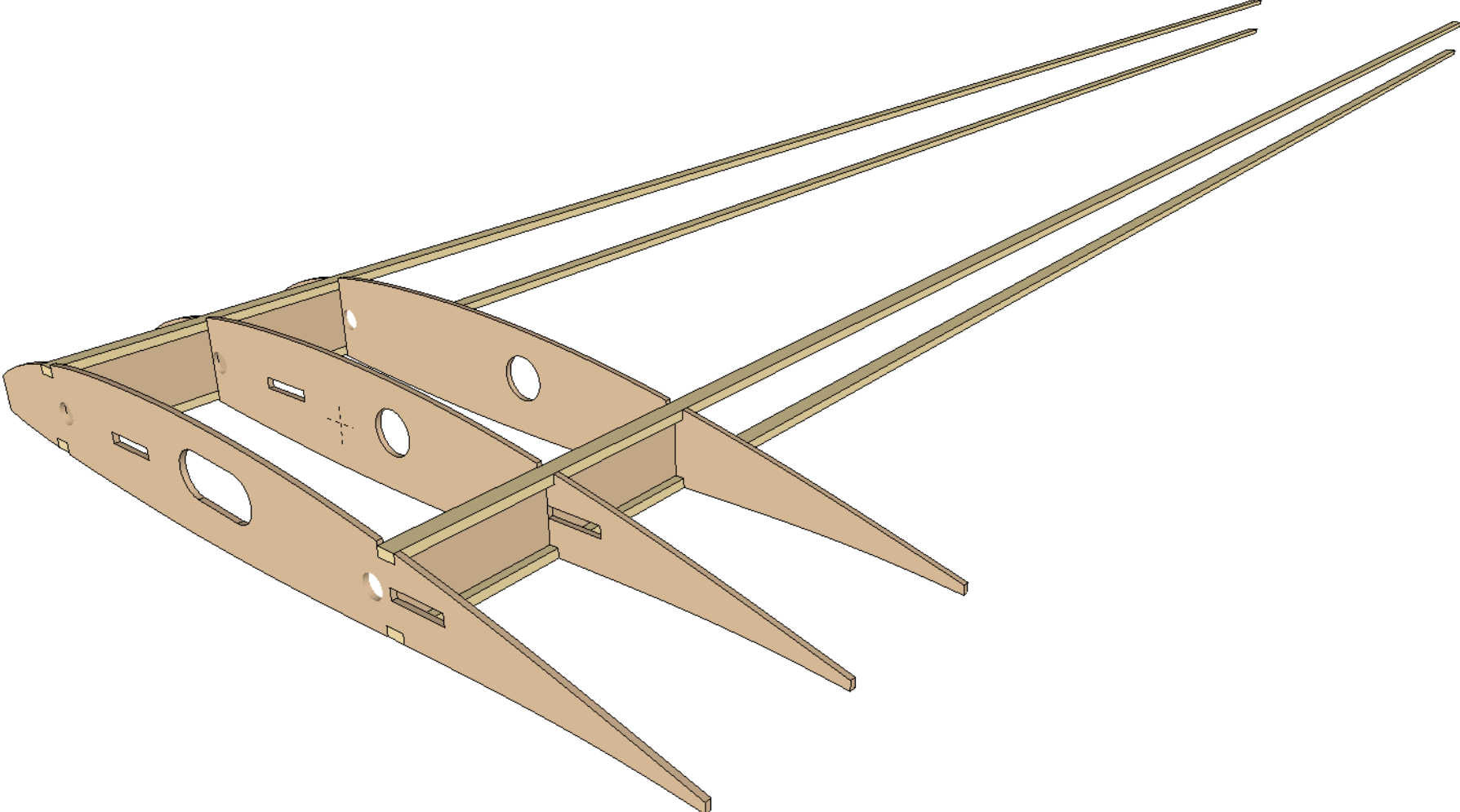

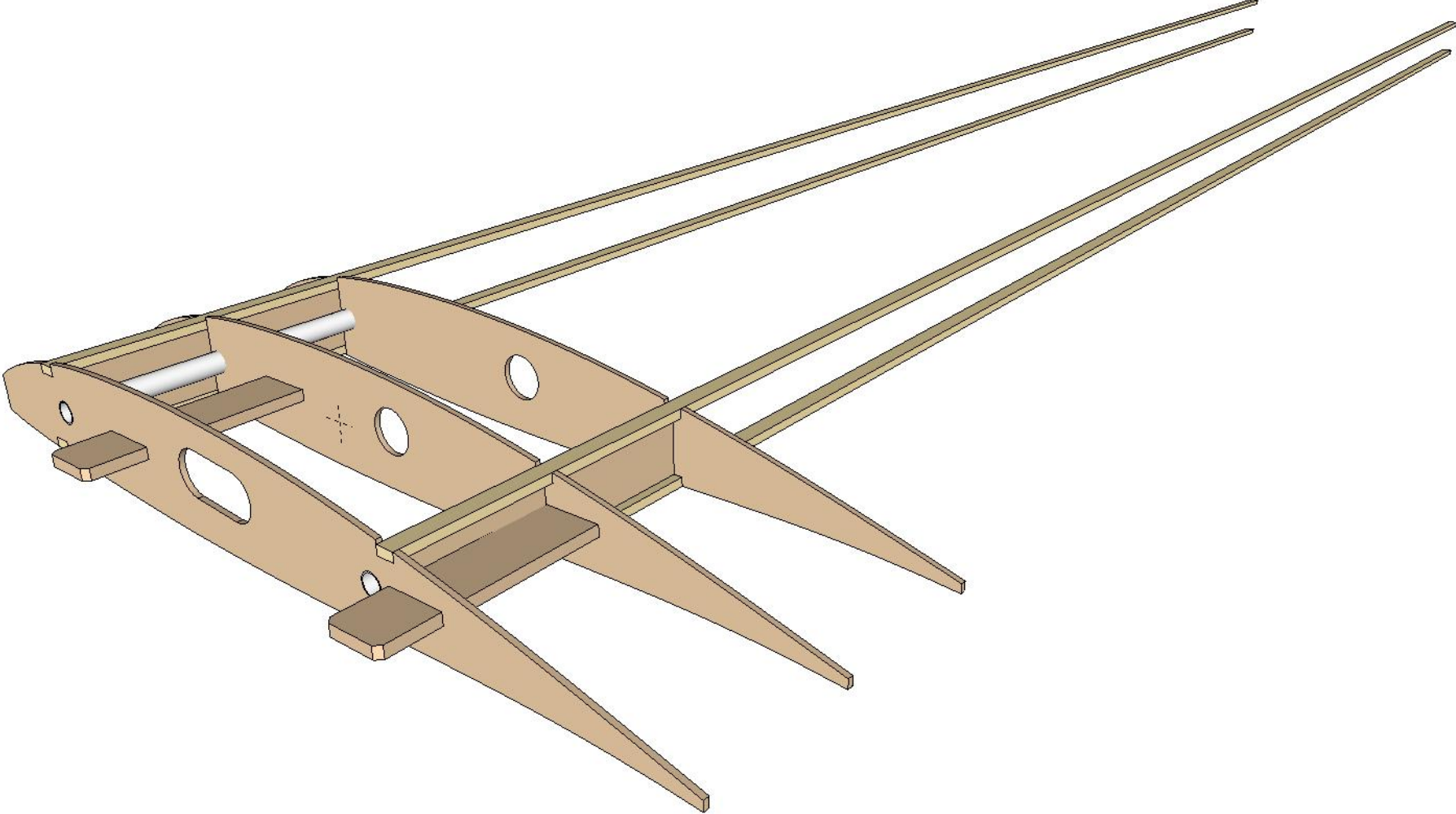

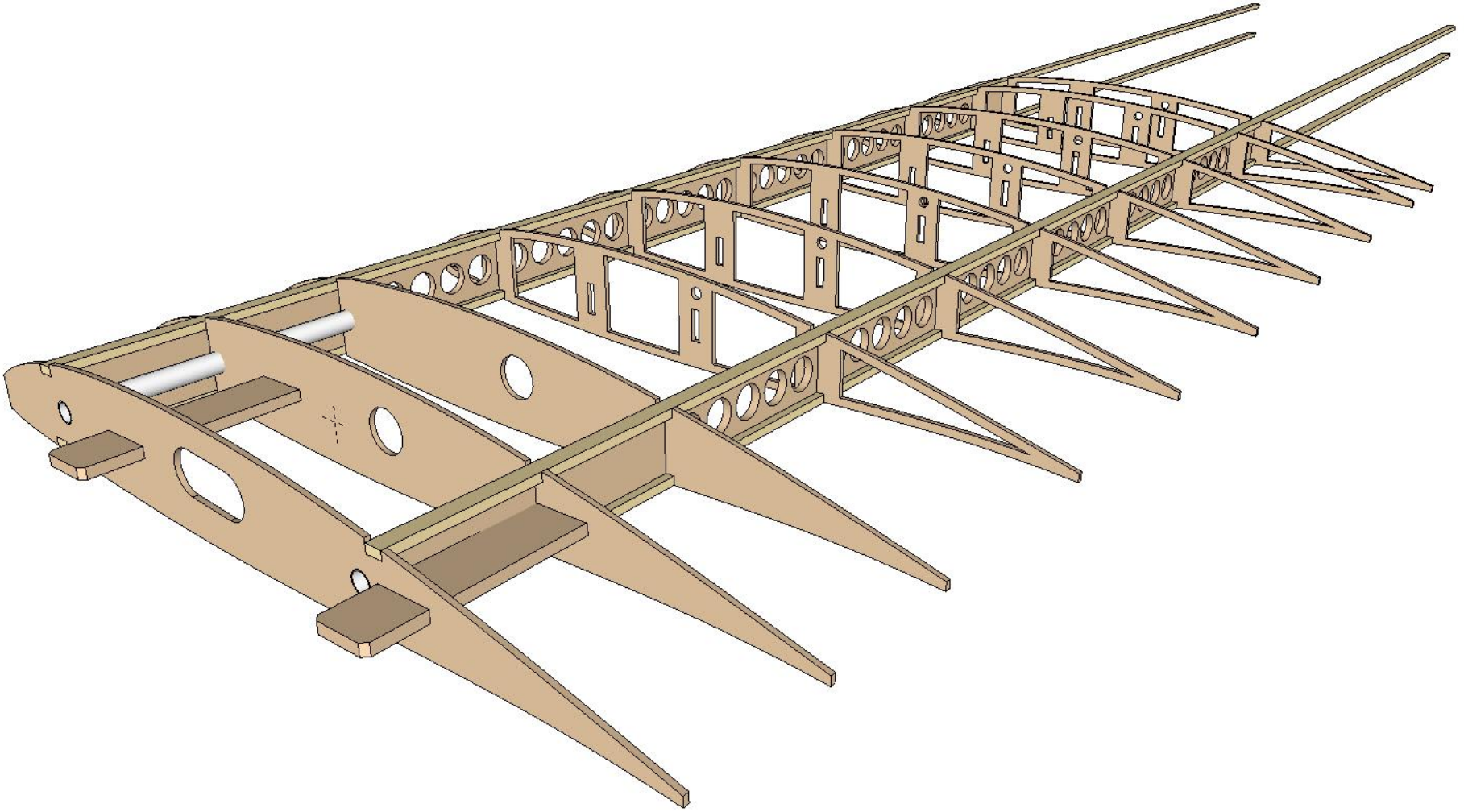



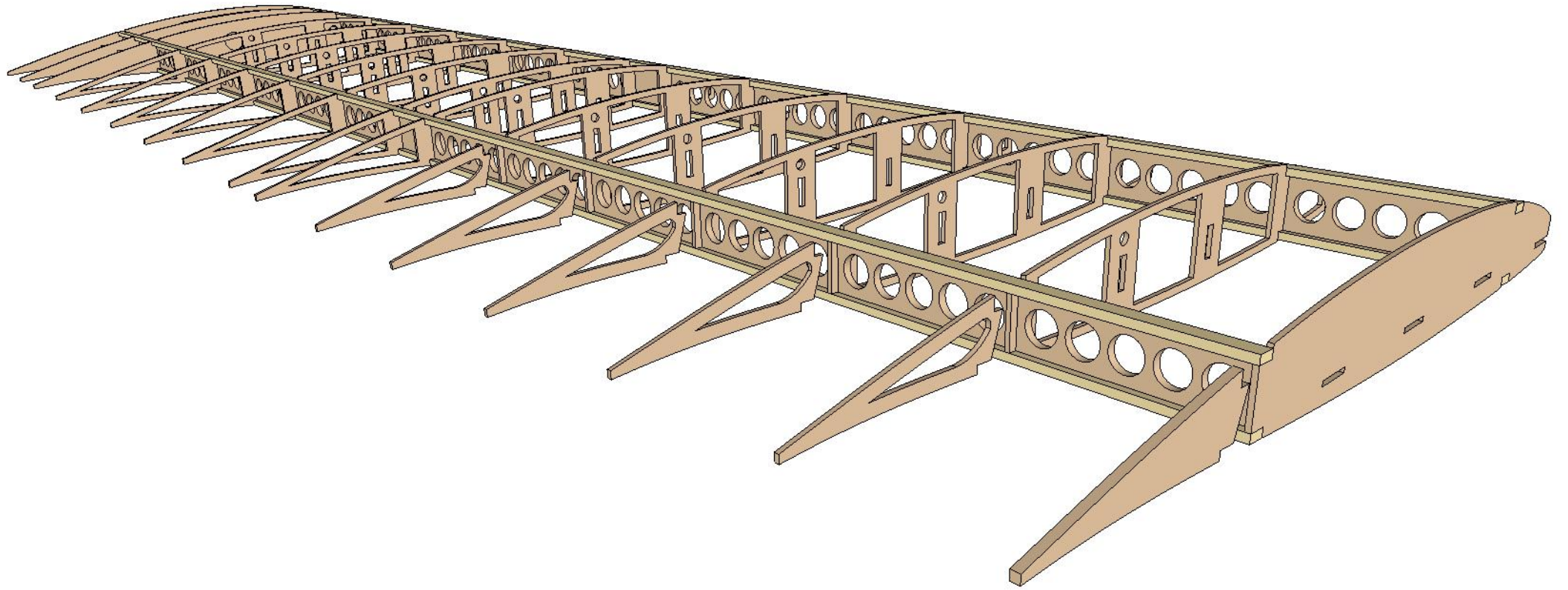

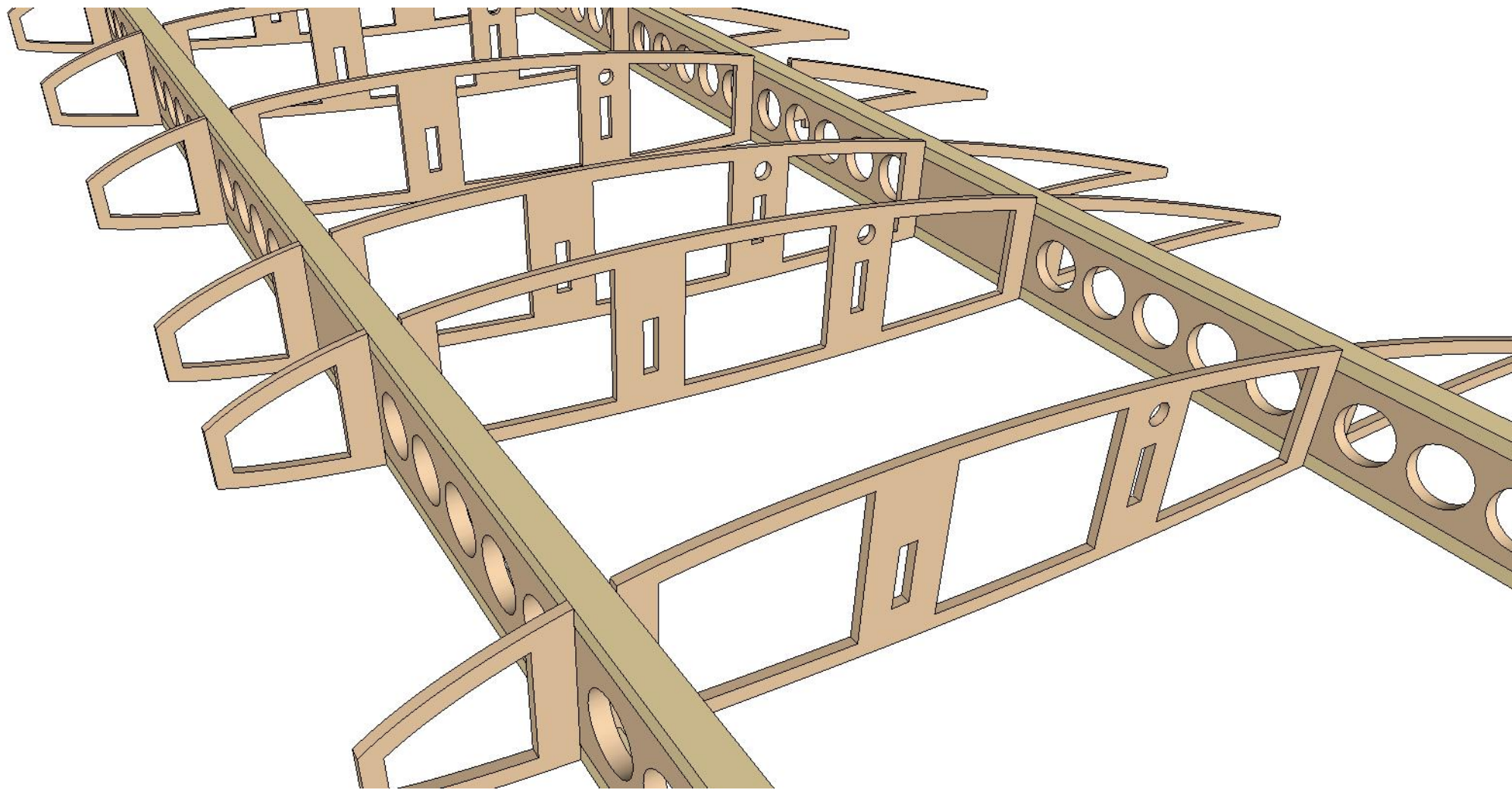

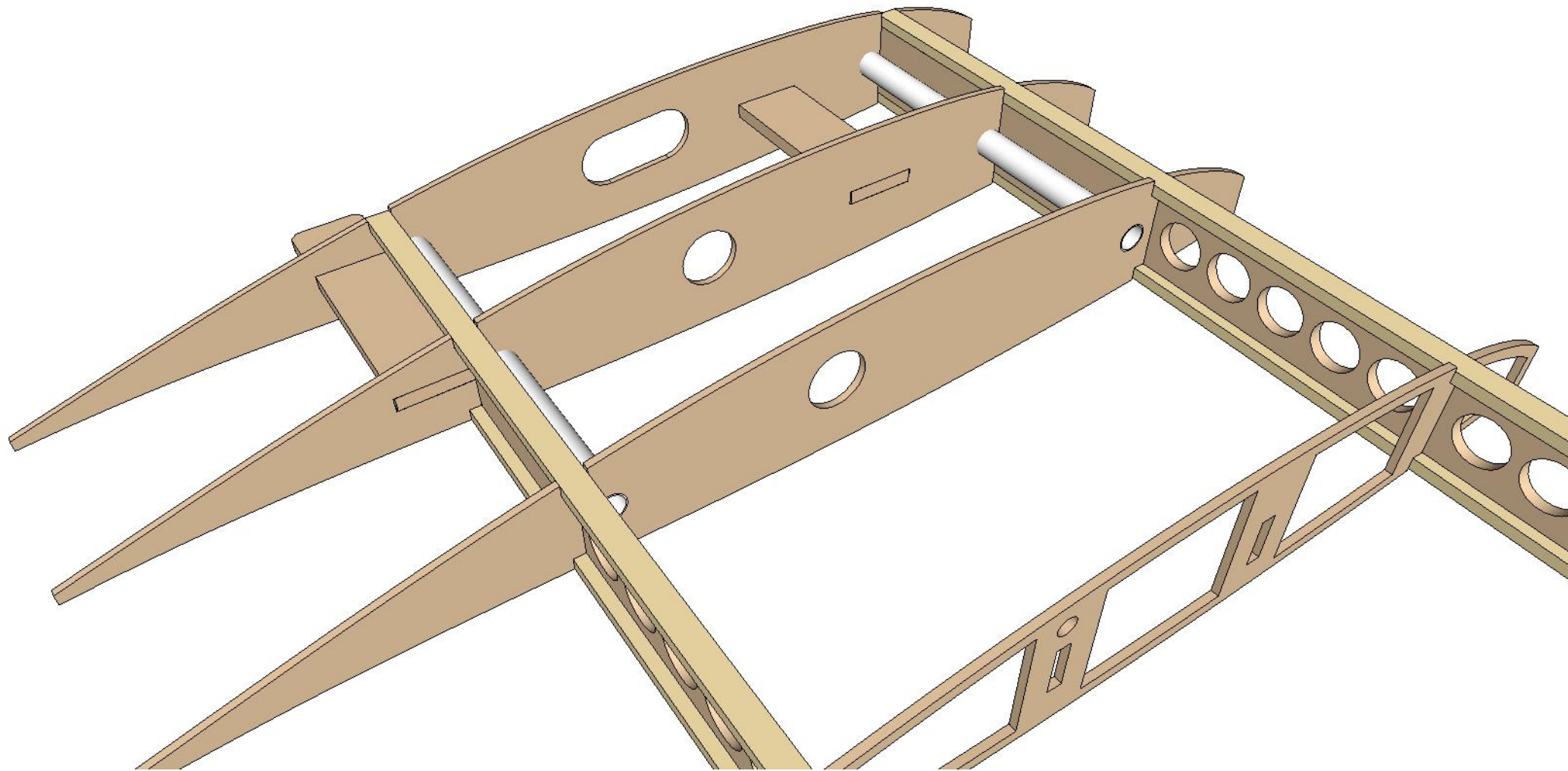



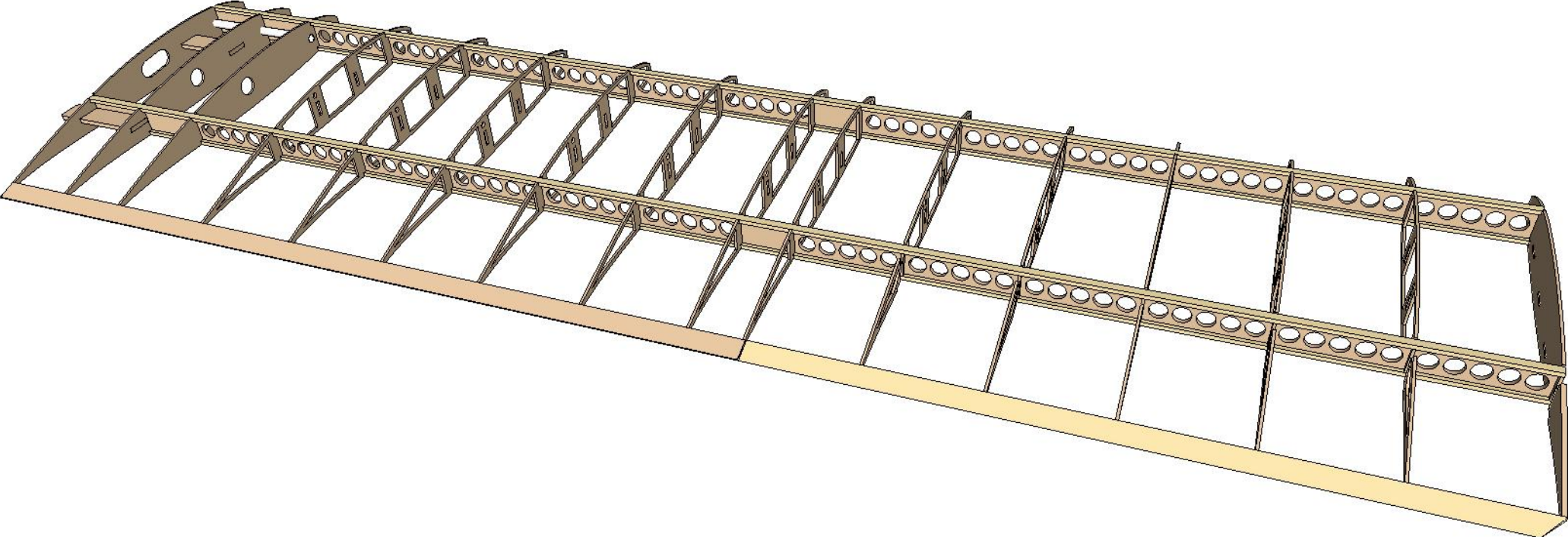

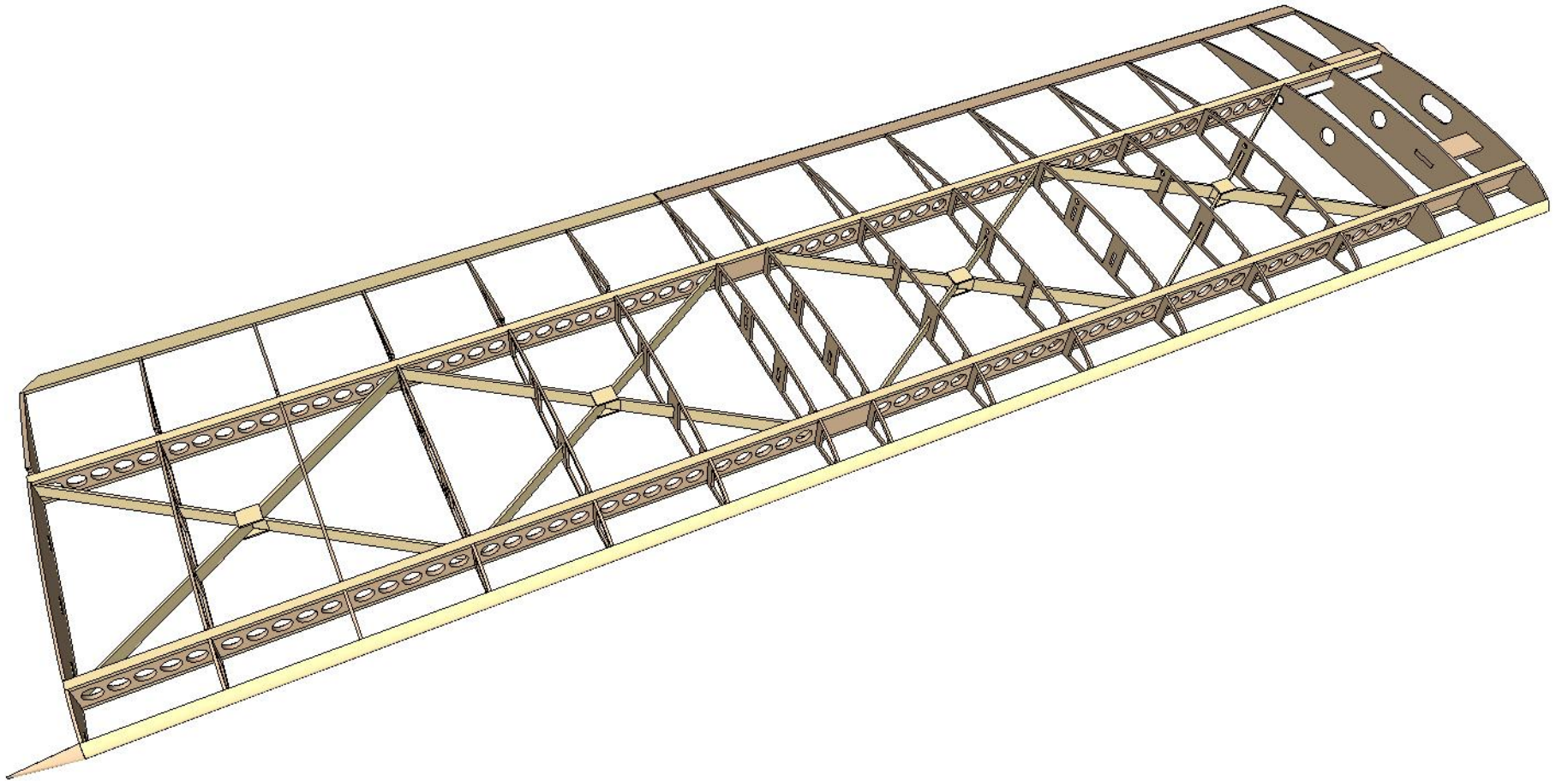

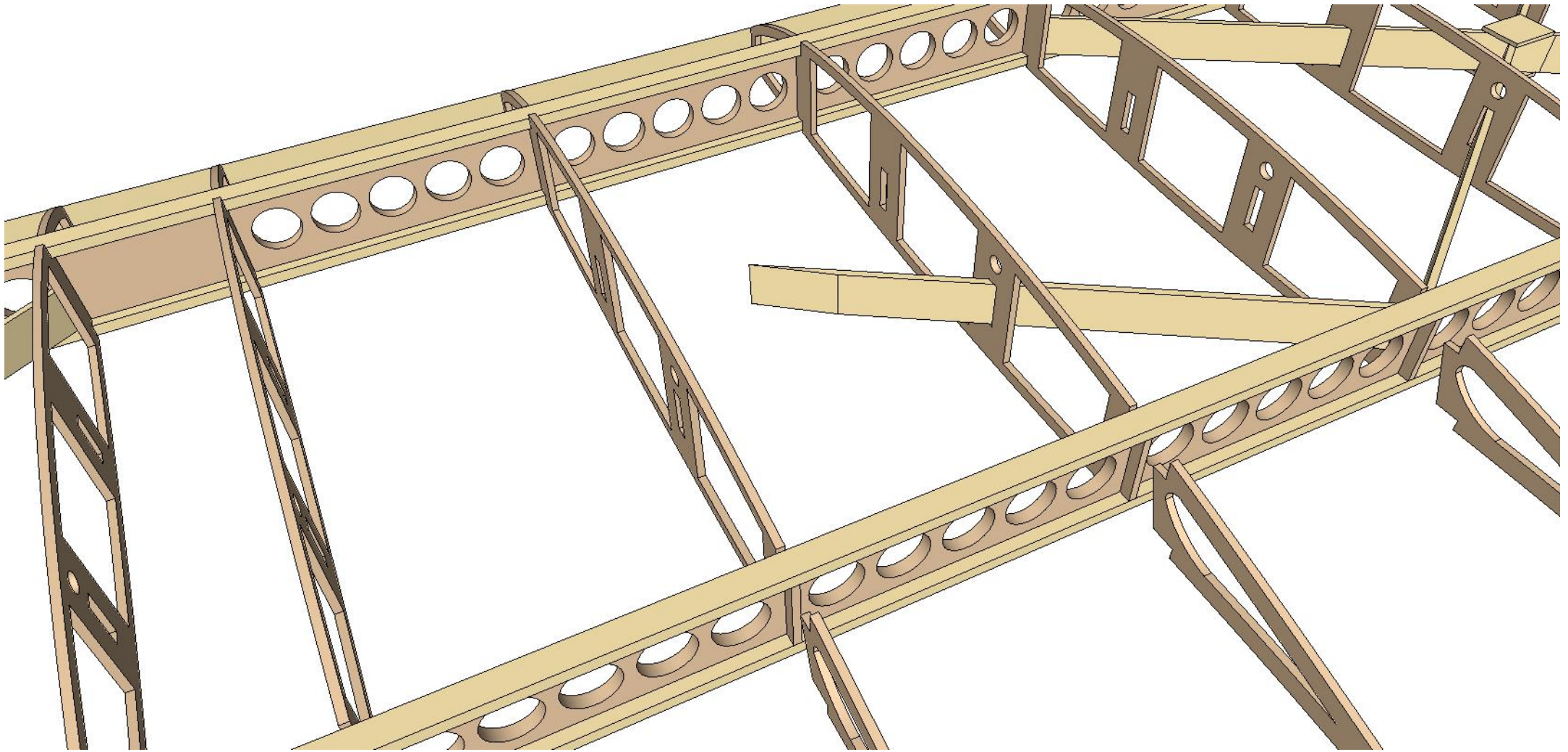



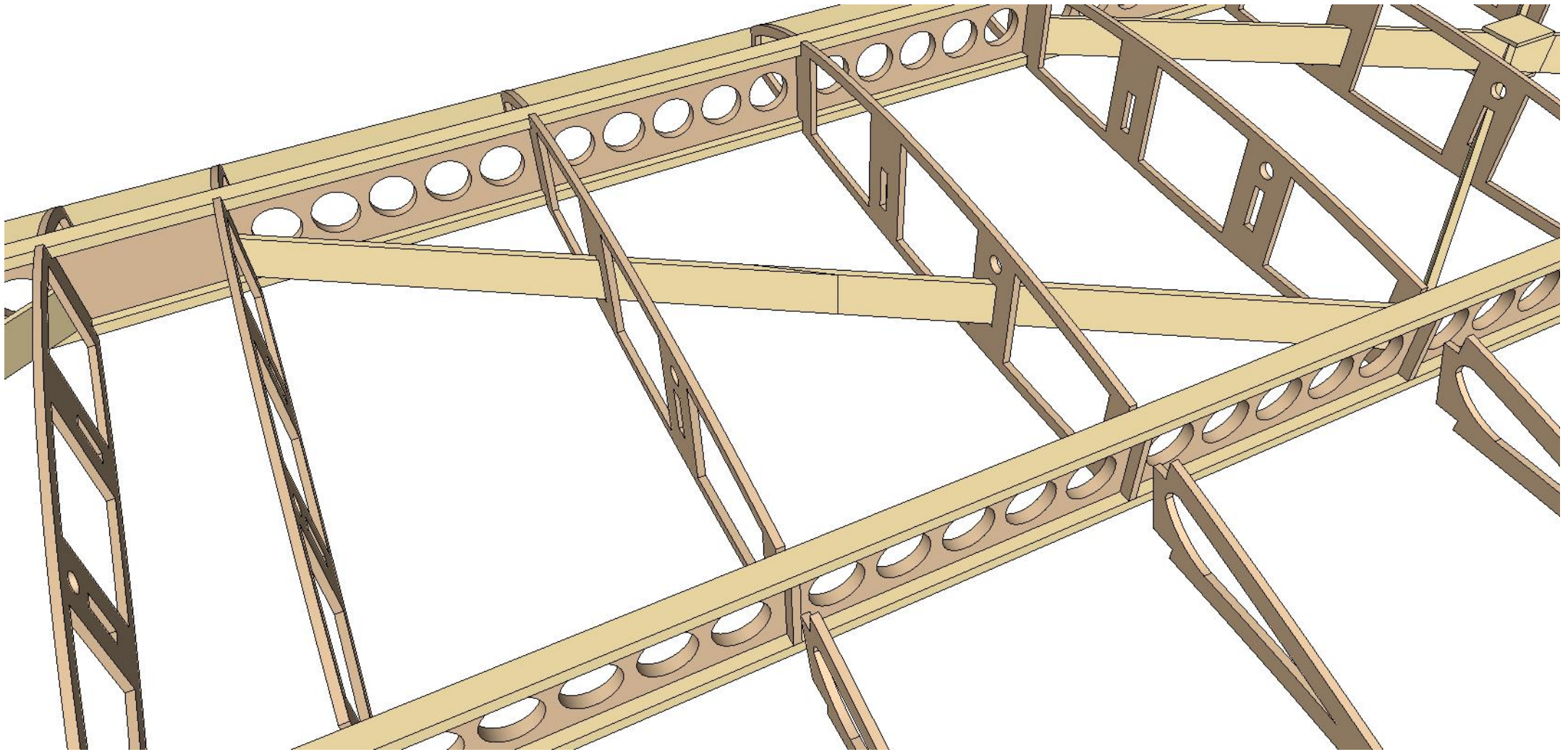



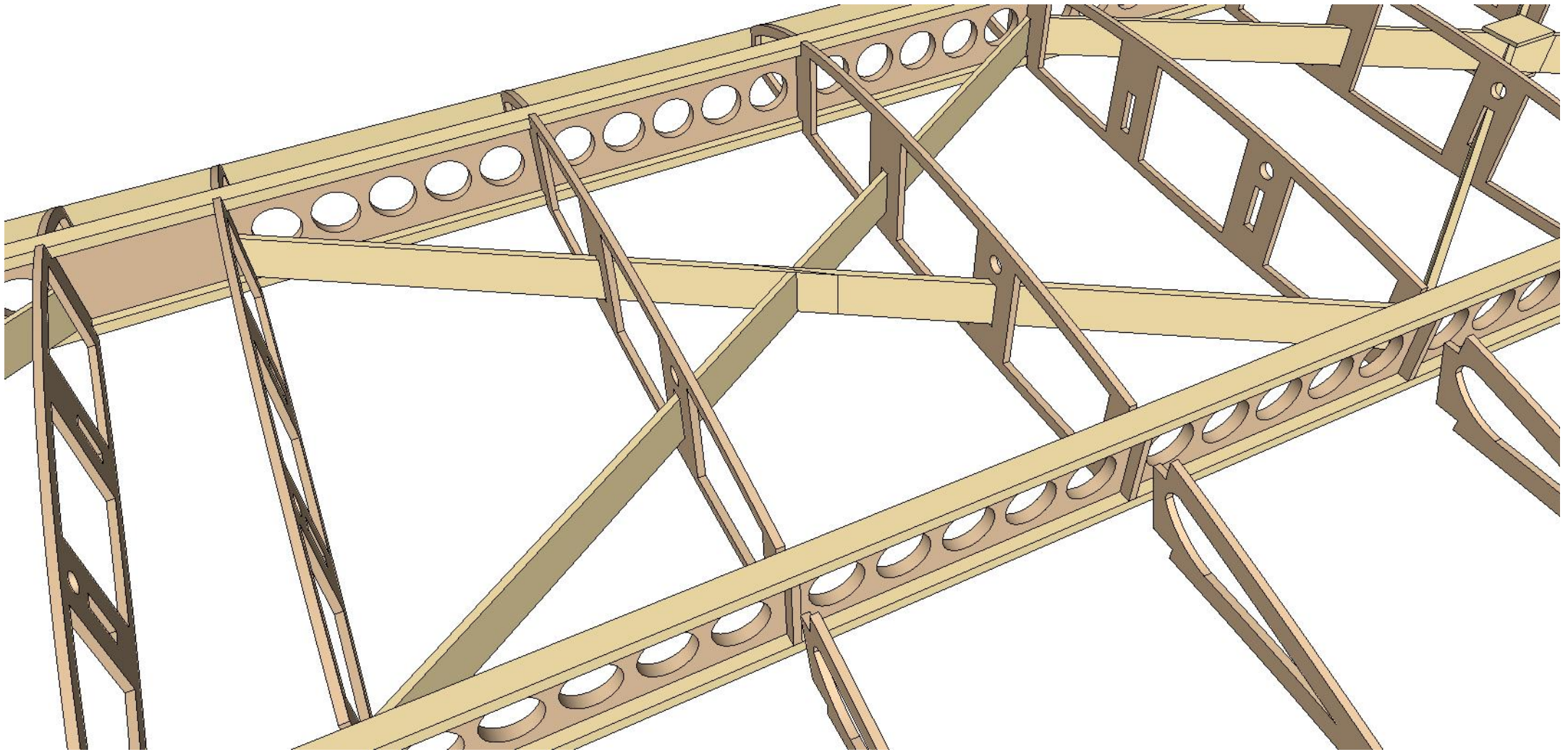

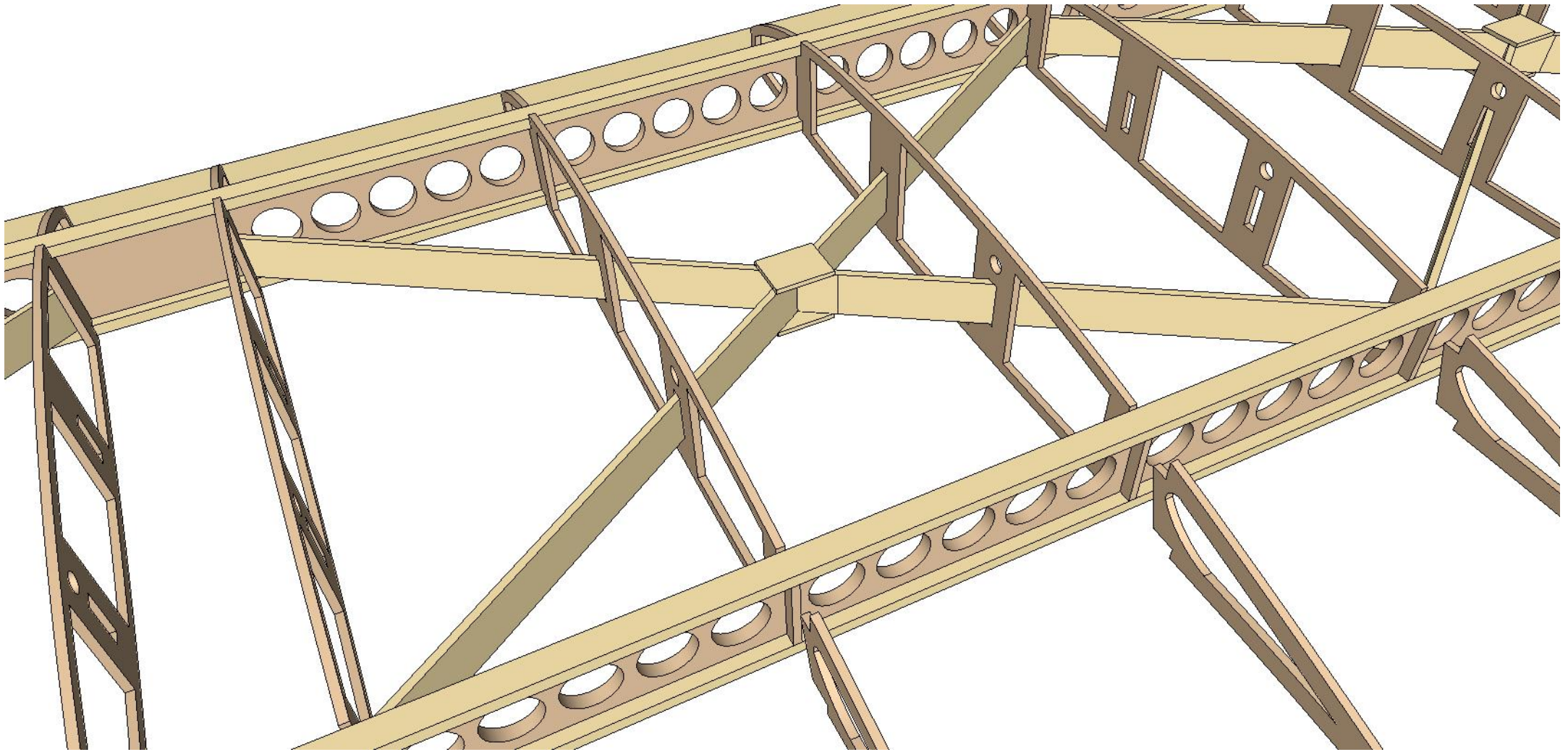



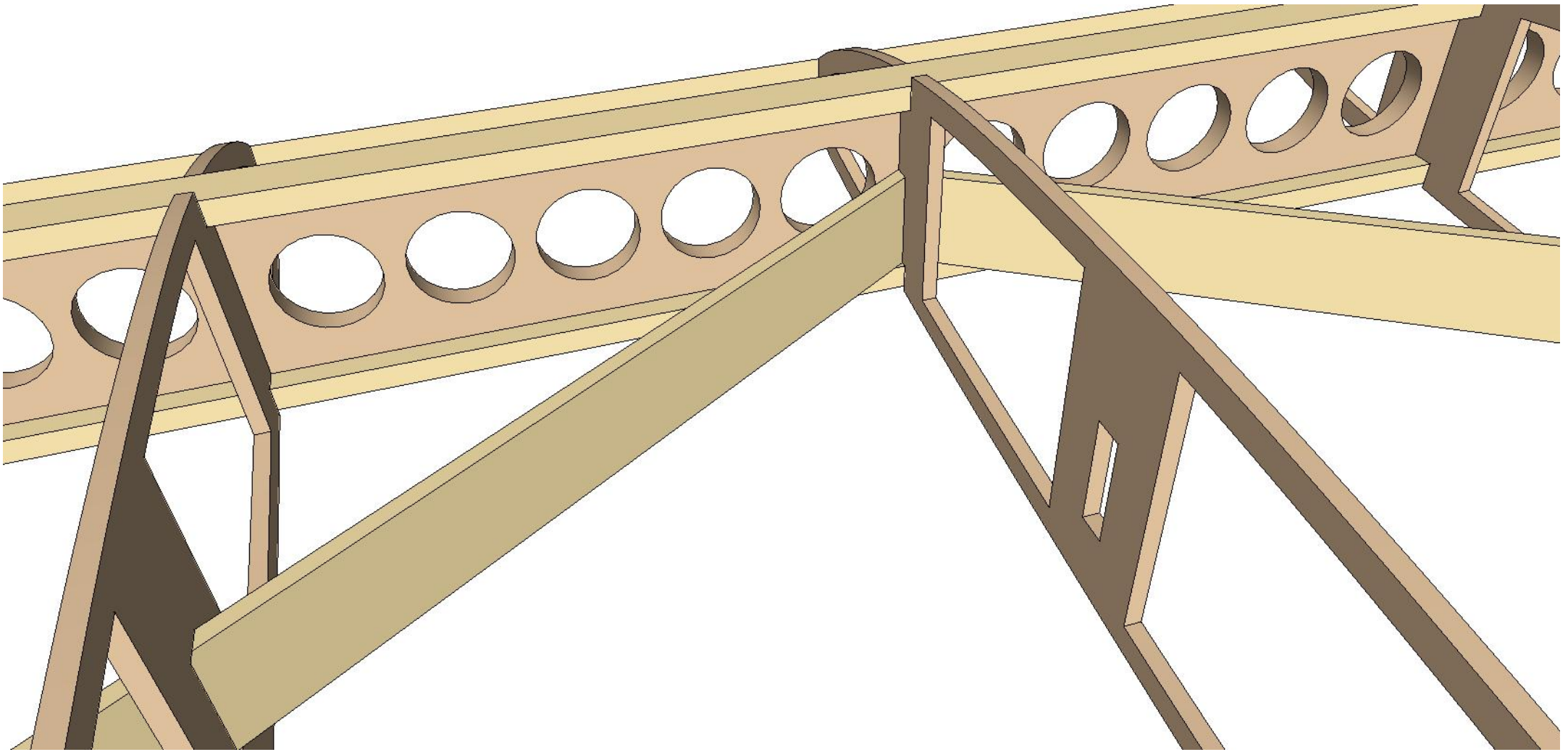

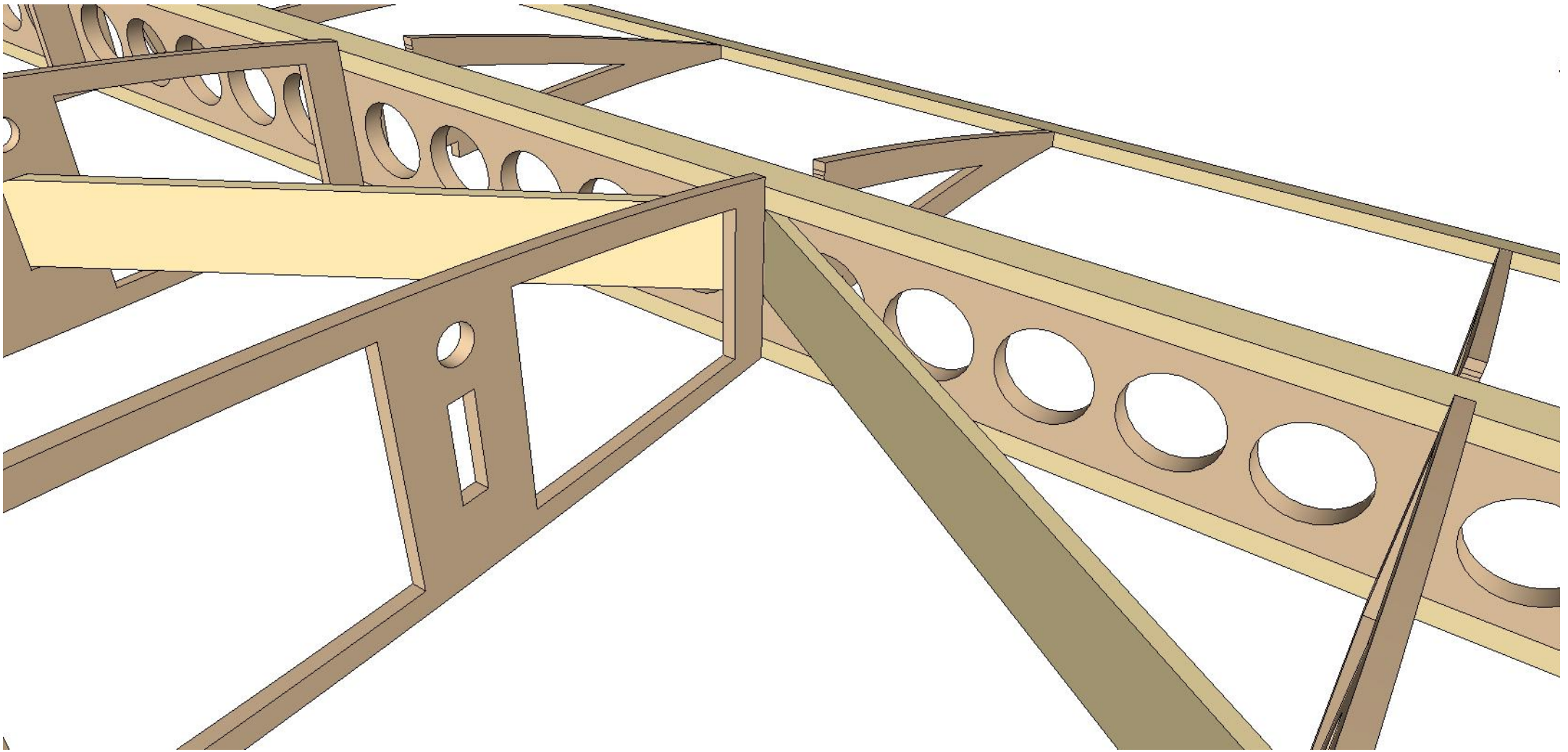



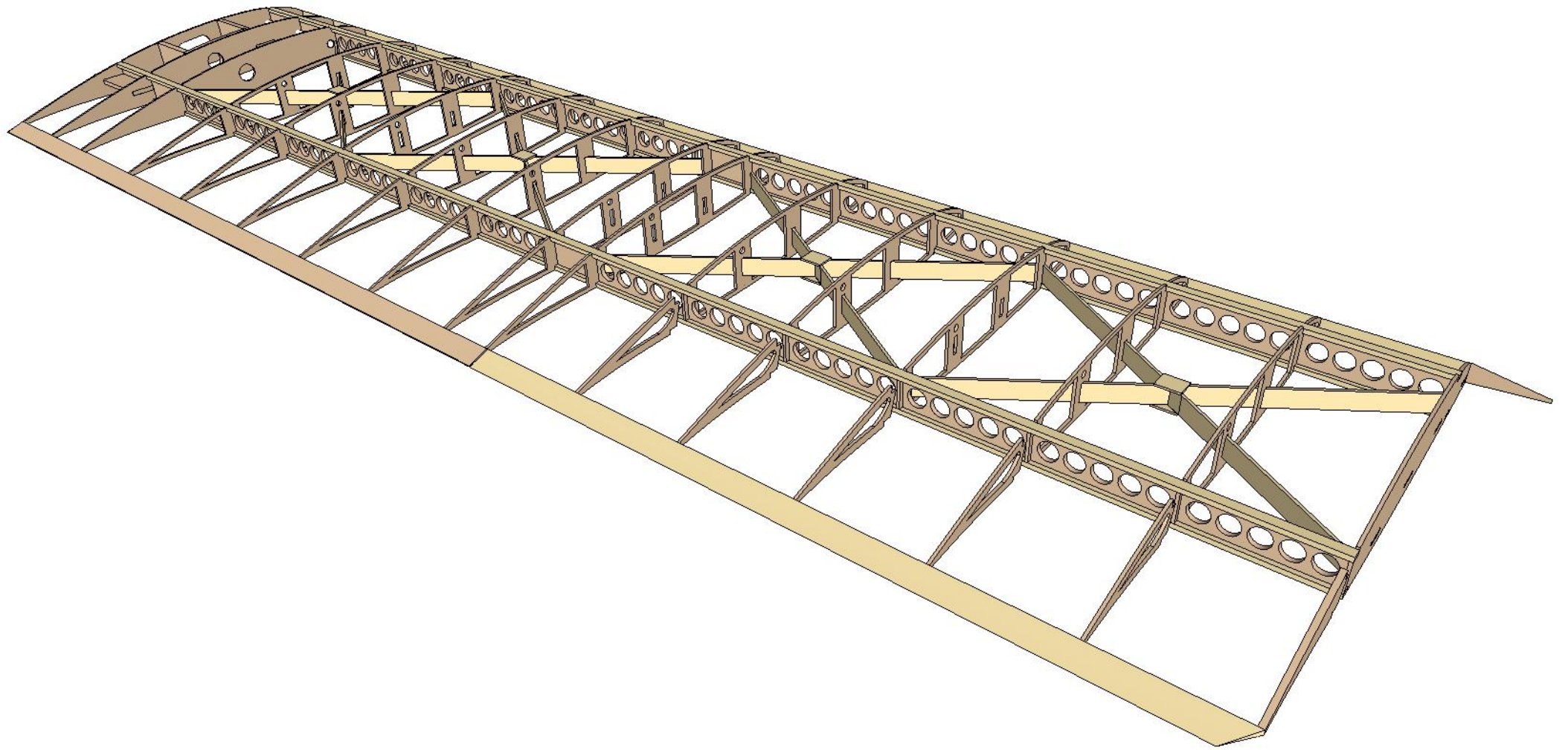

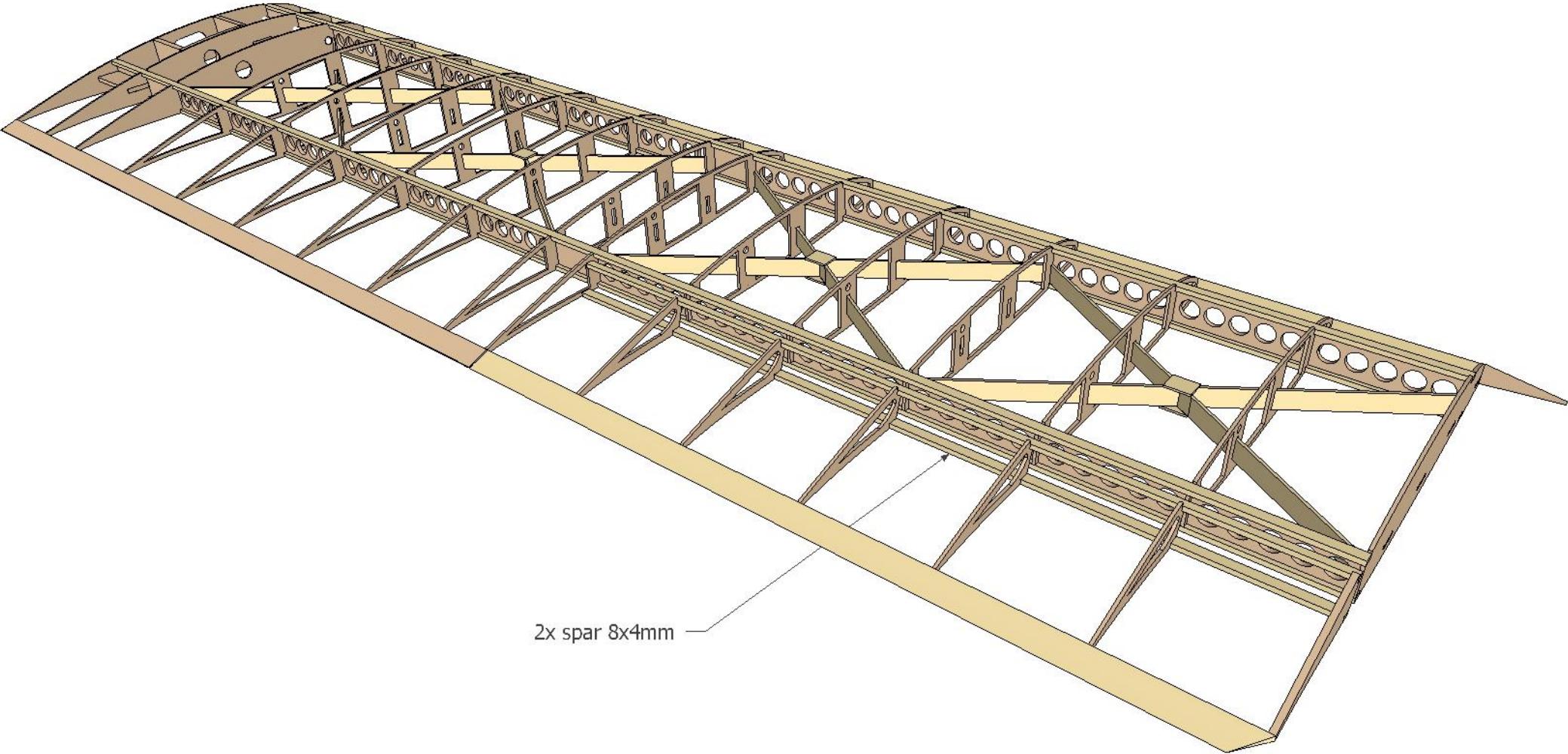

2x spar 8x4mm

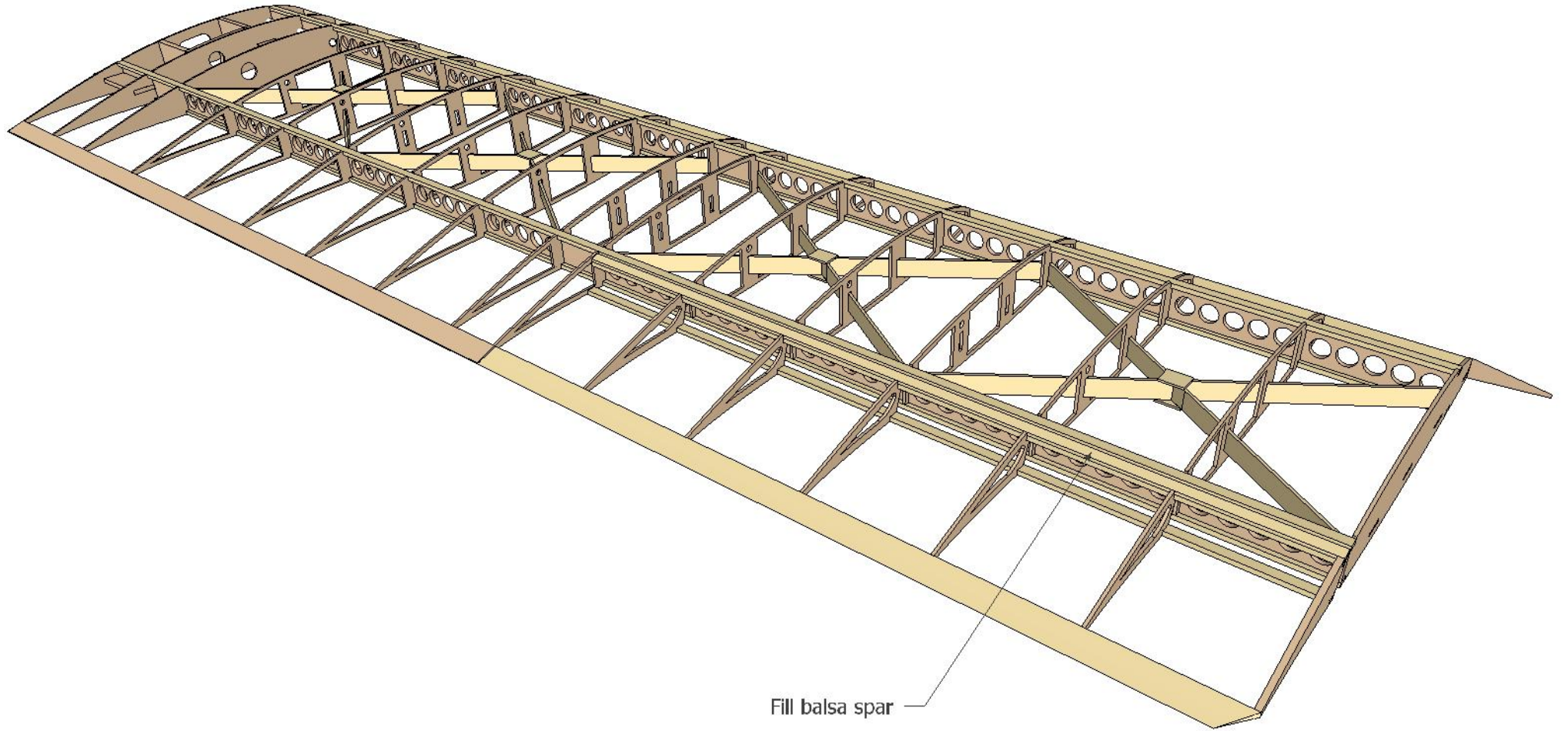

Fill balsa spar



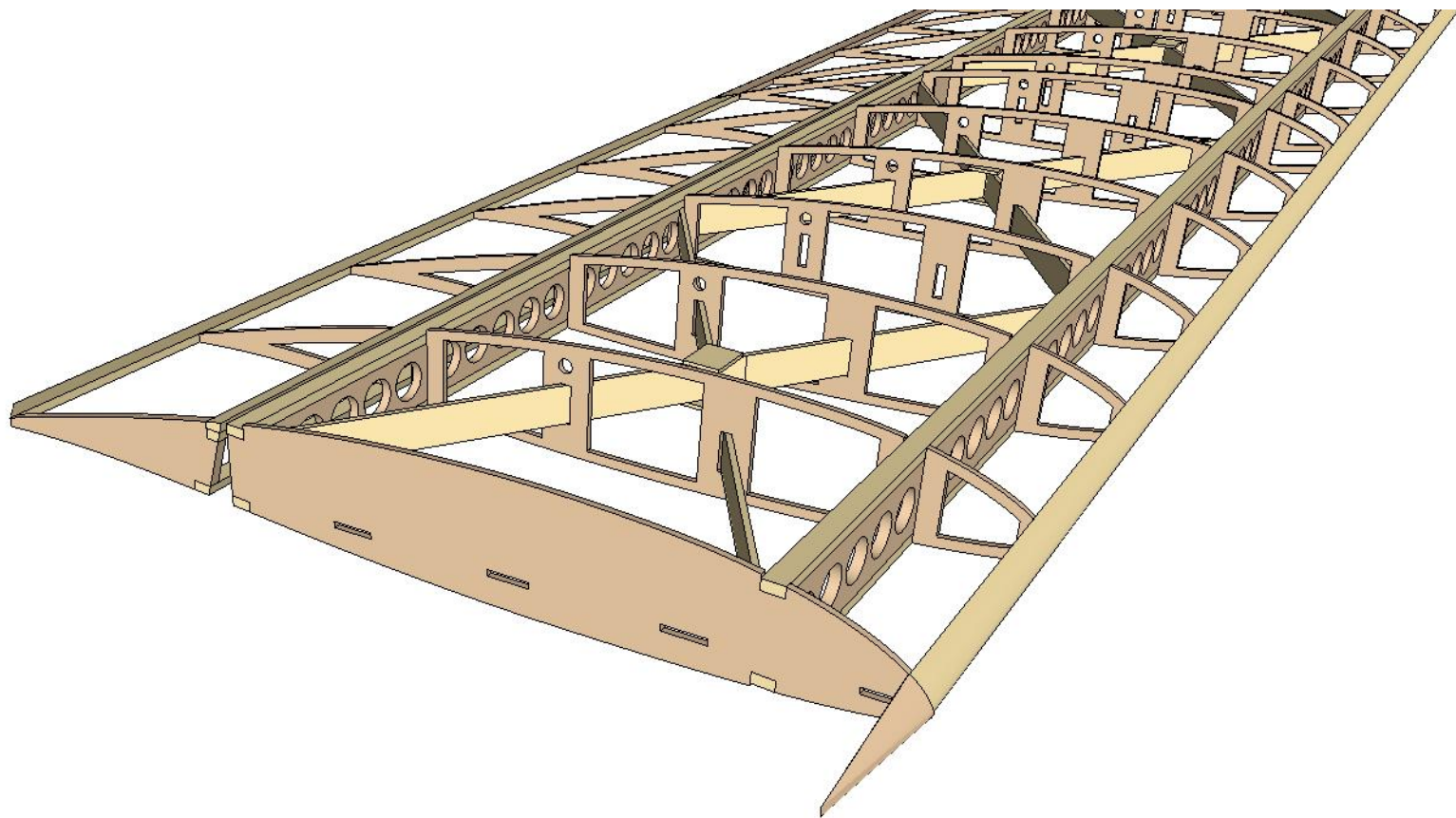



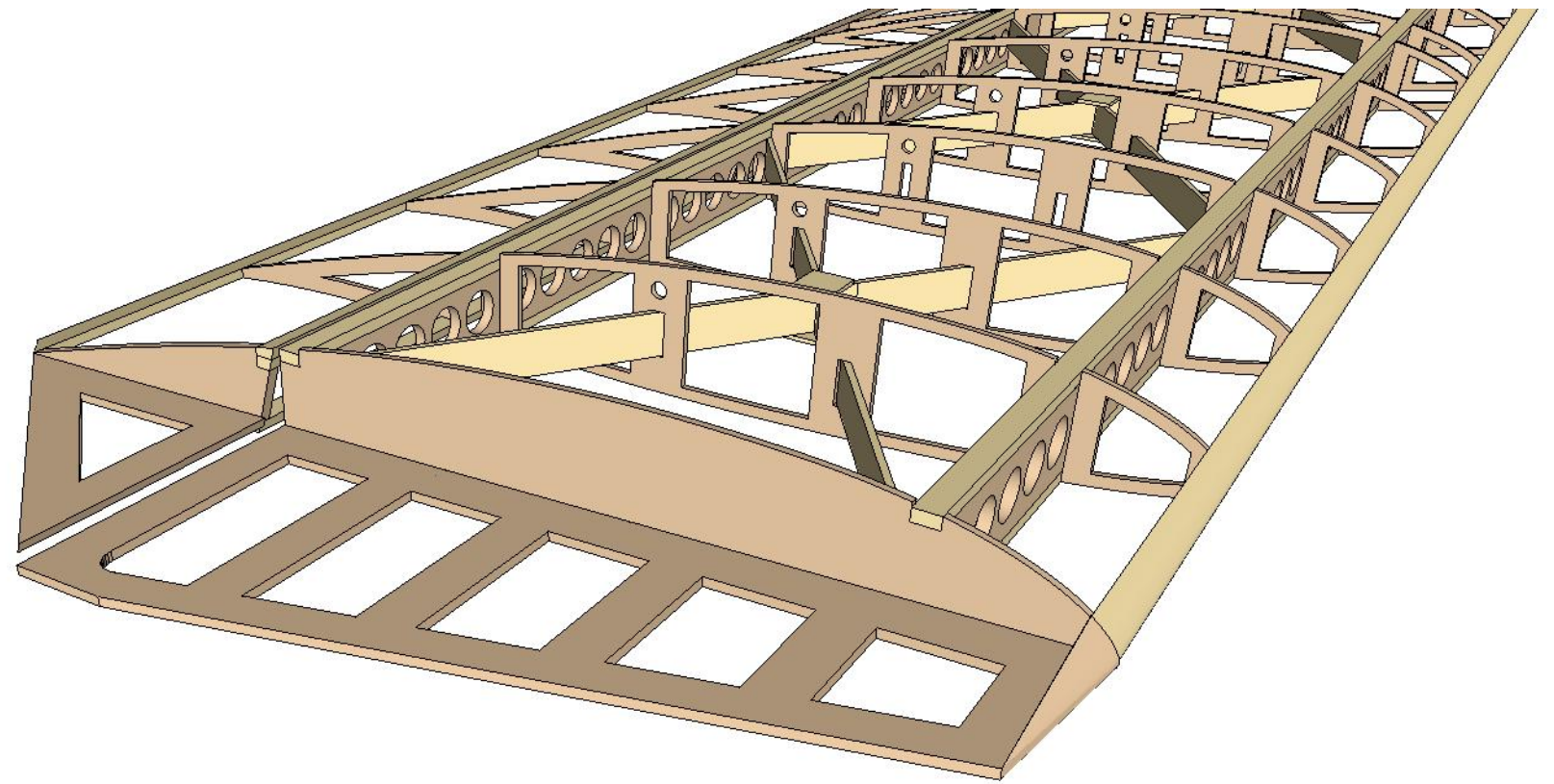

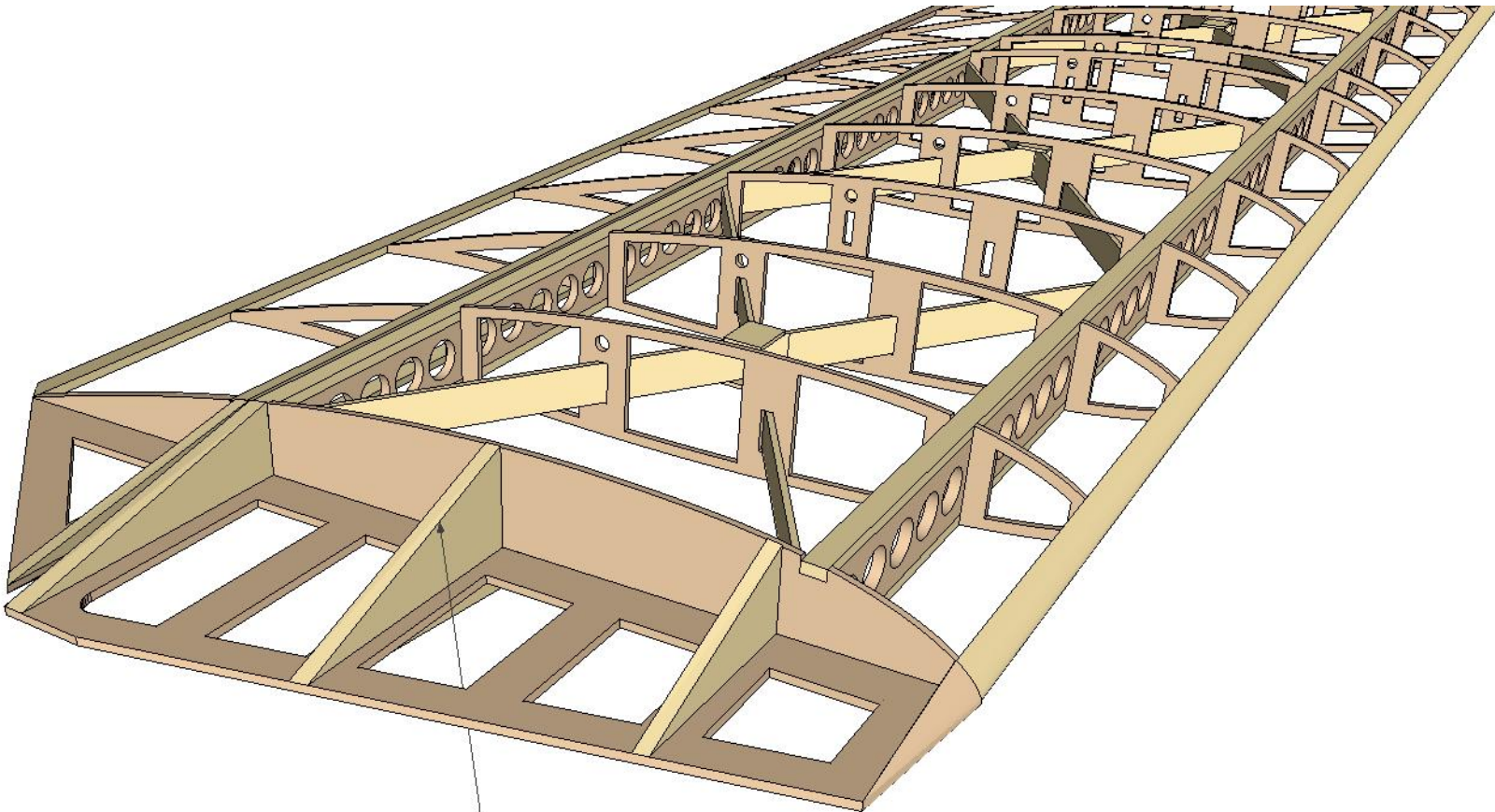

Balsa block 8 mm

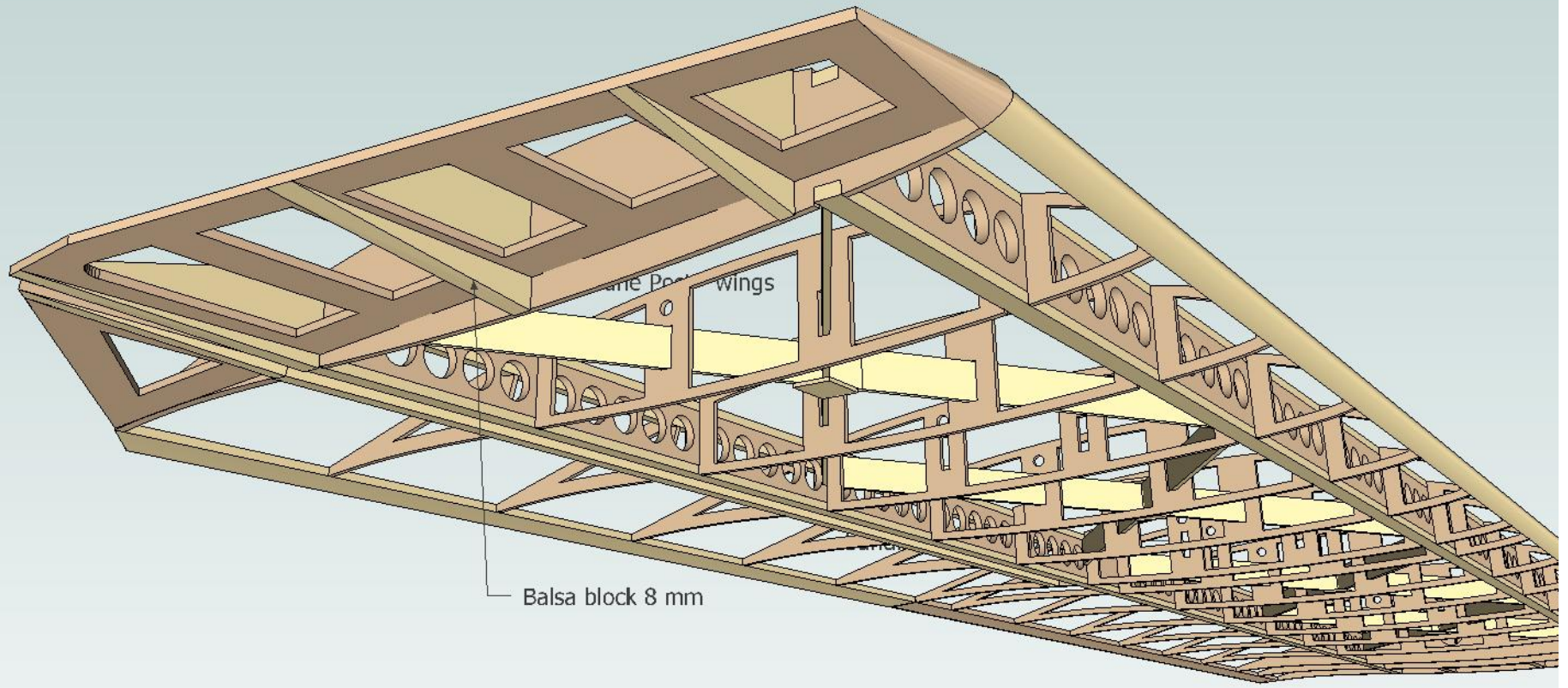

Balsa block 8 mm

Wing Post wings



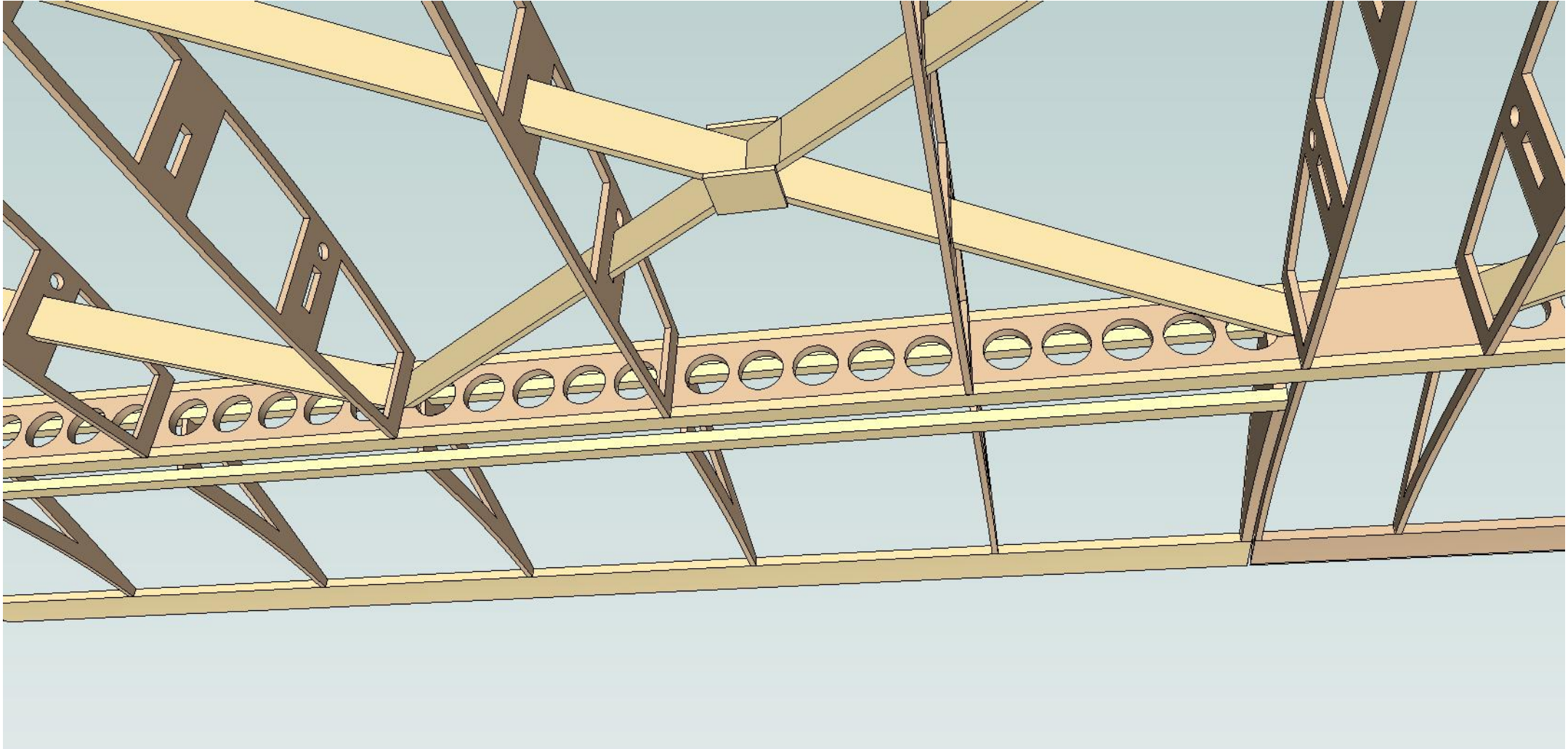

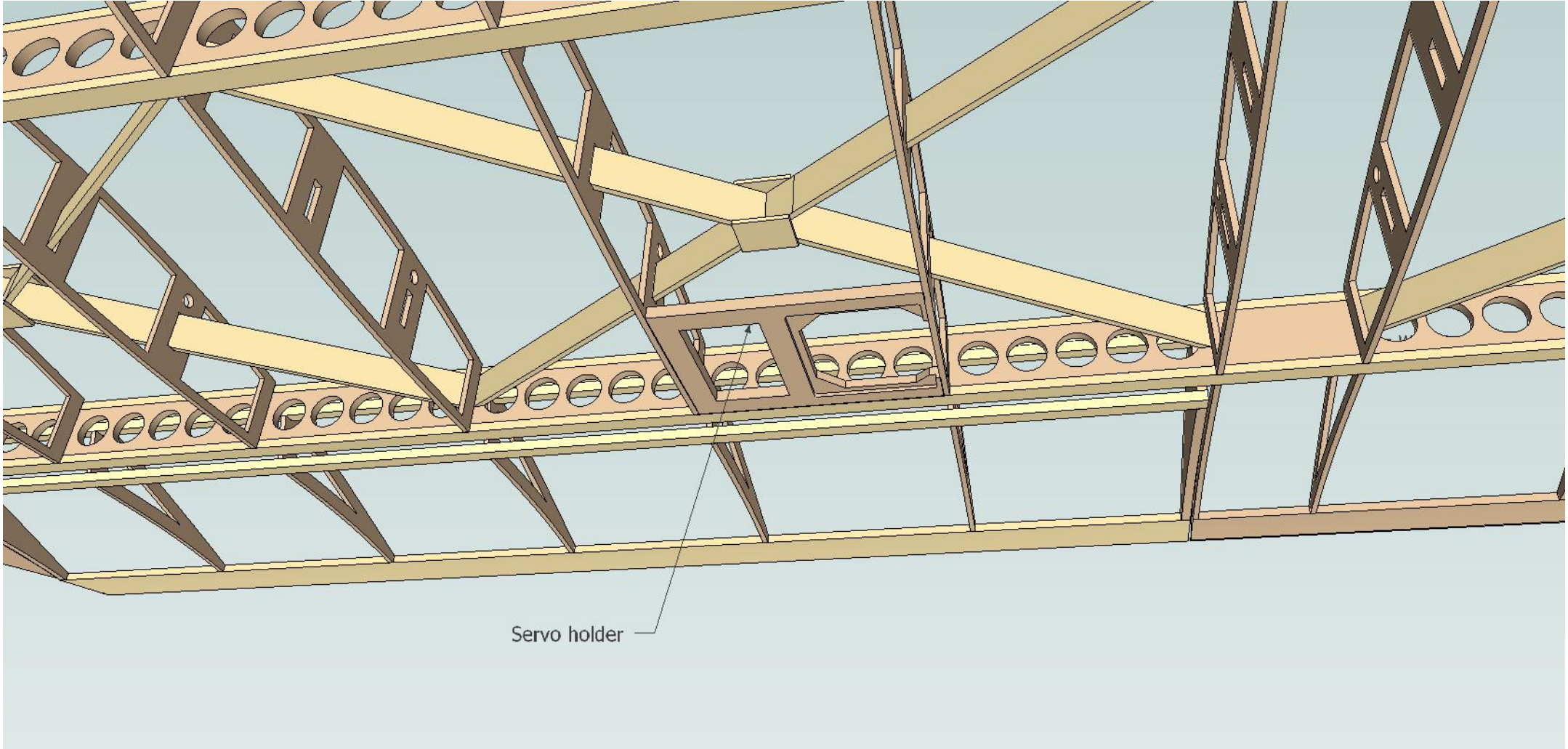

Servo holder



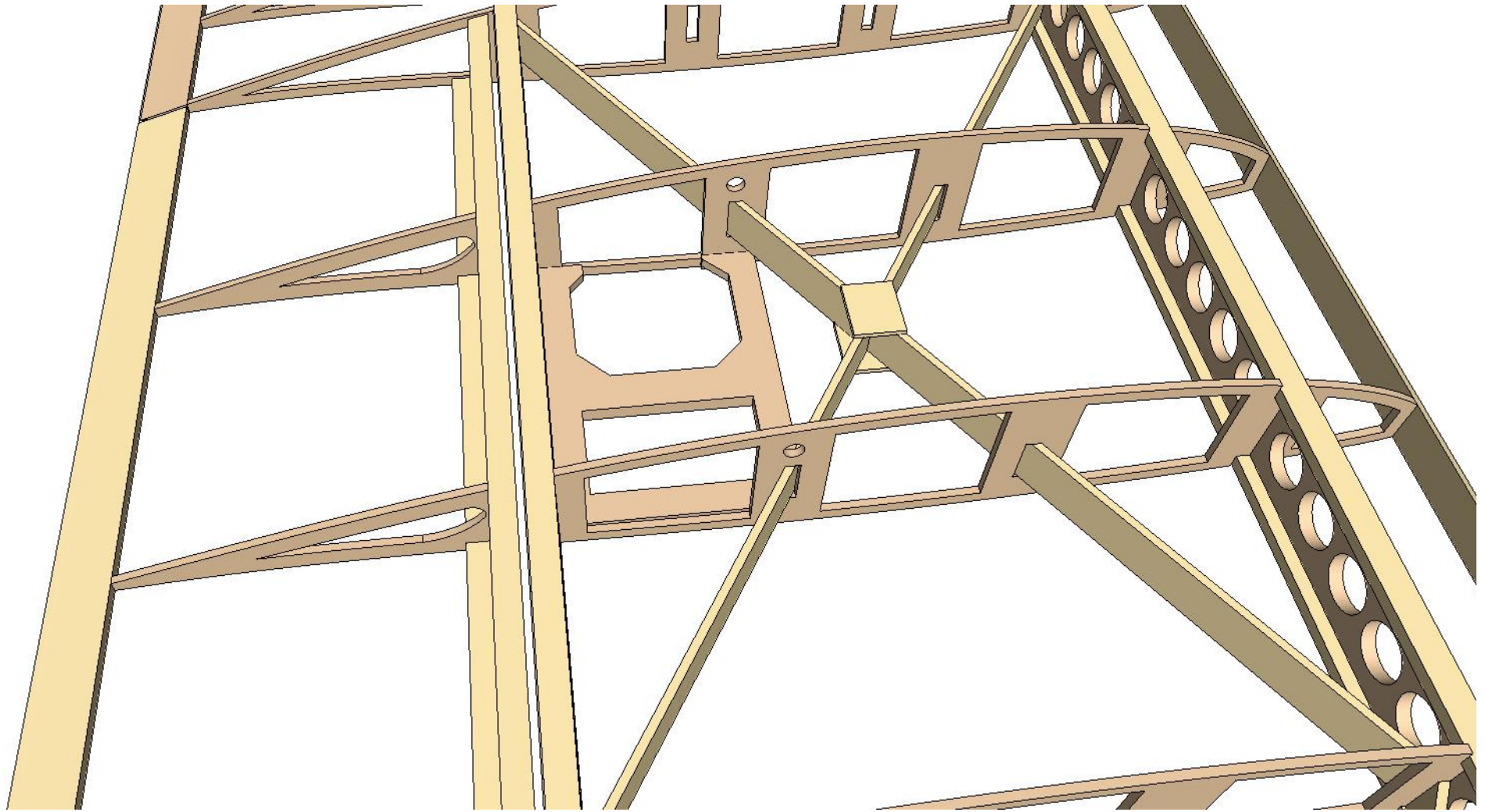



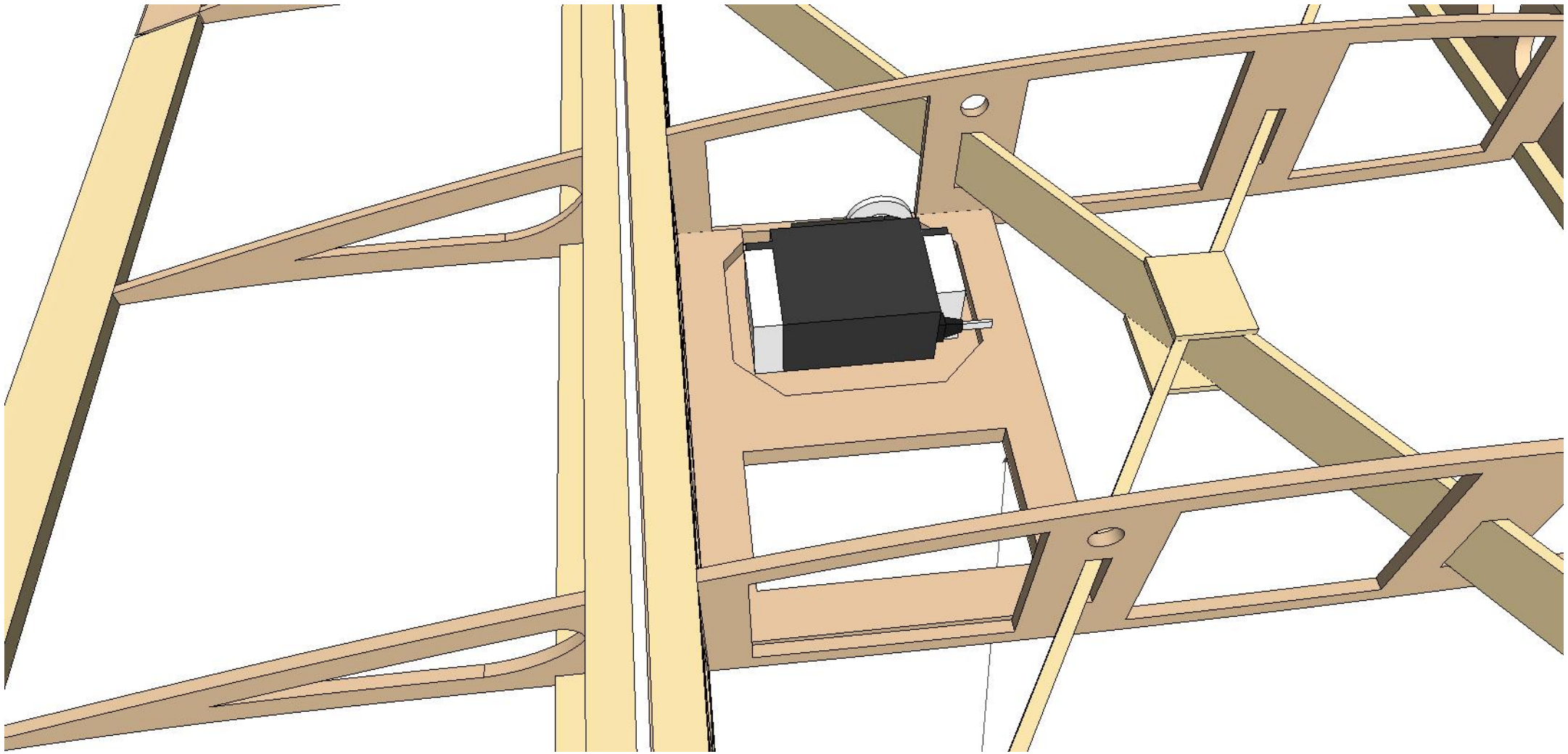

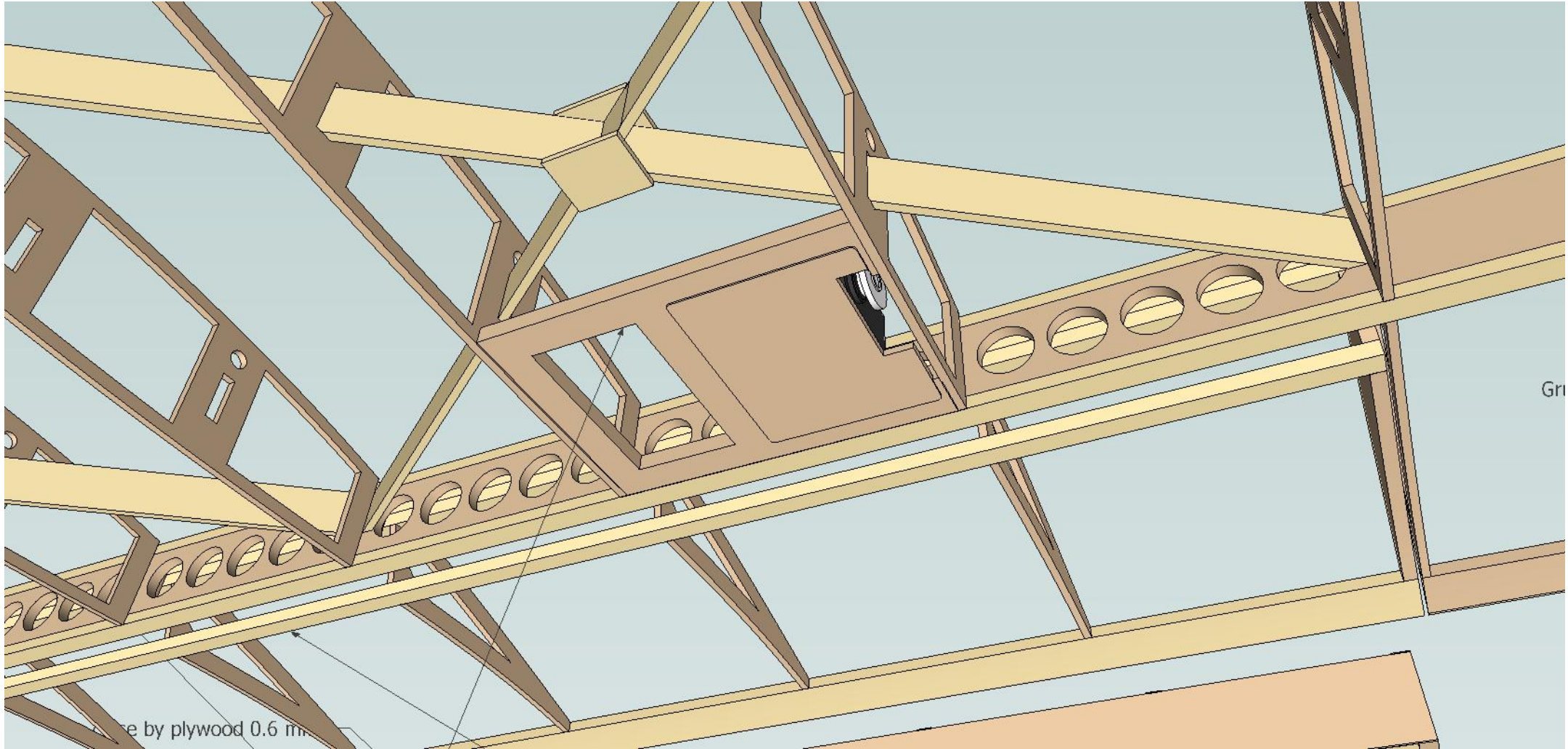

Gr

...e by plywood 0.6 mm







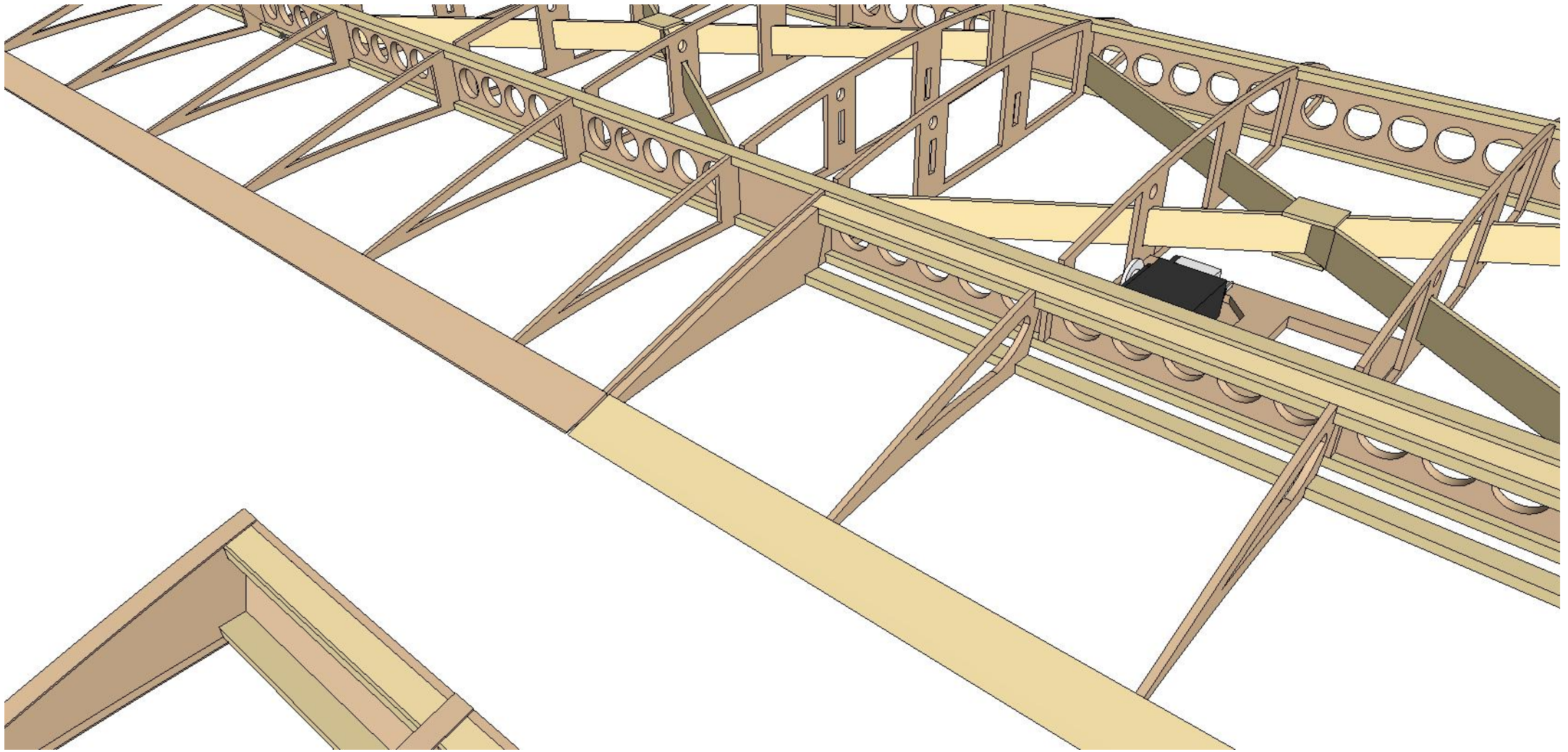

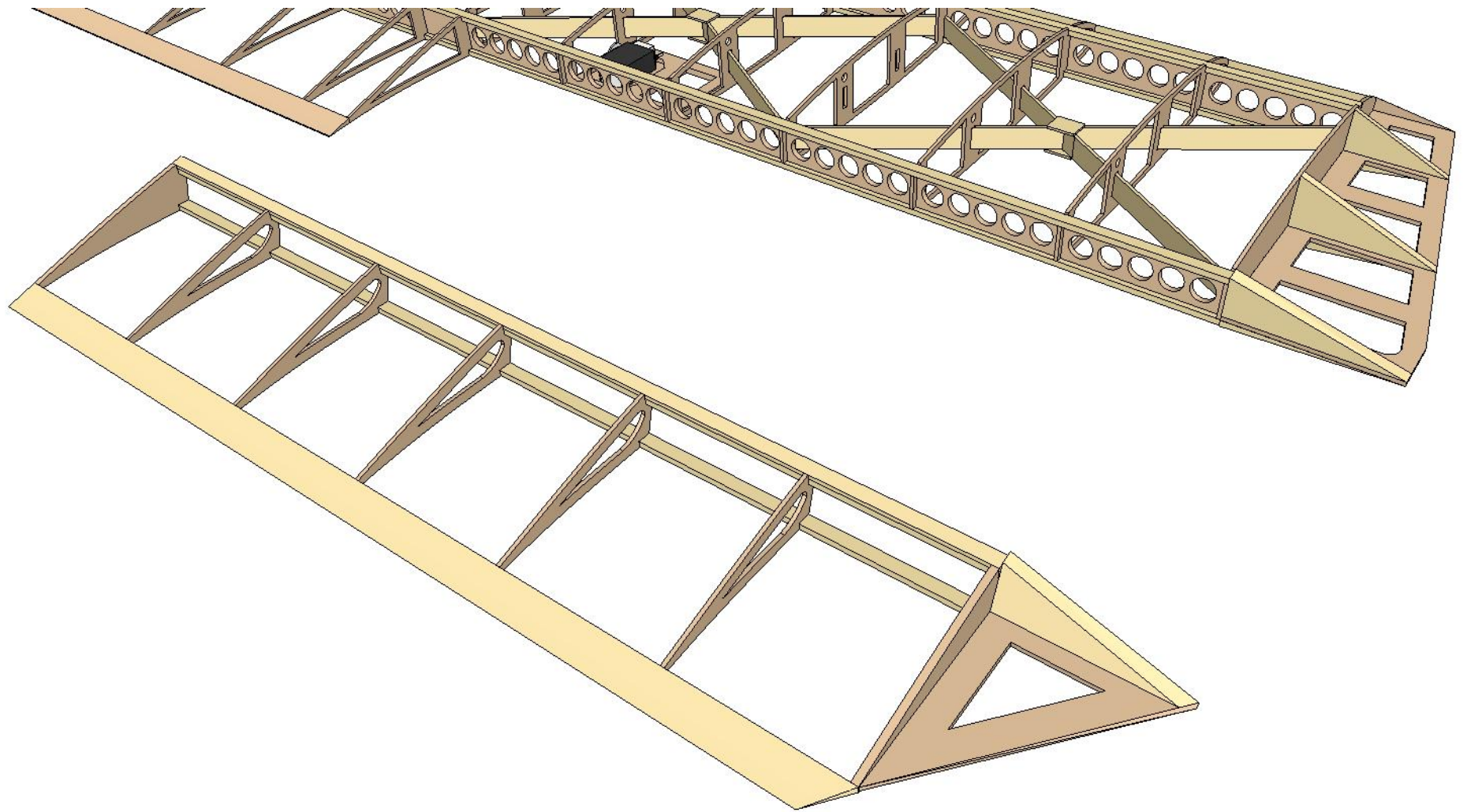



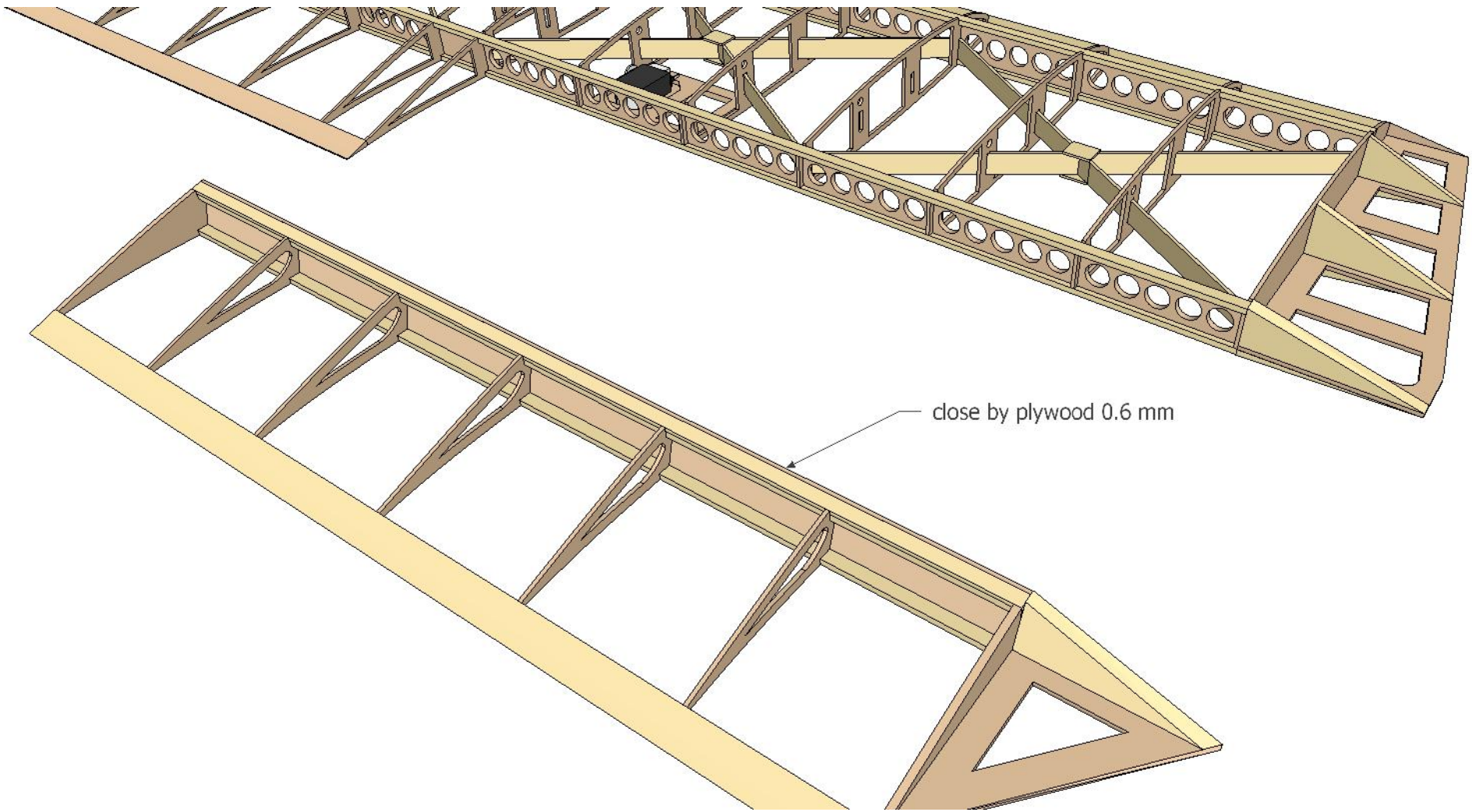

close by plywood 0.6 mm



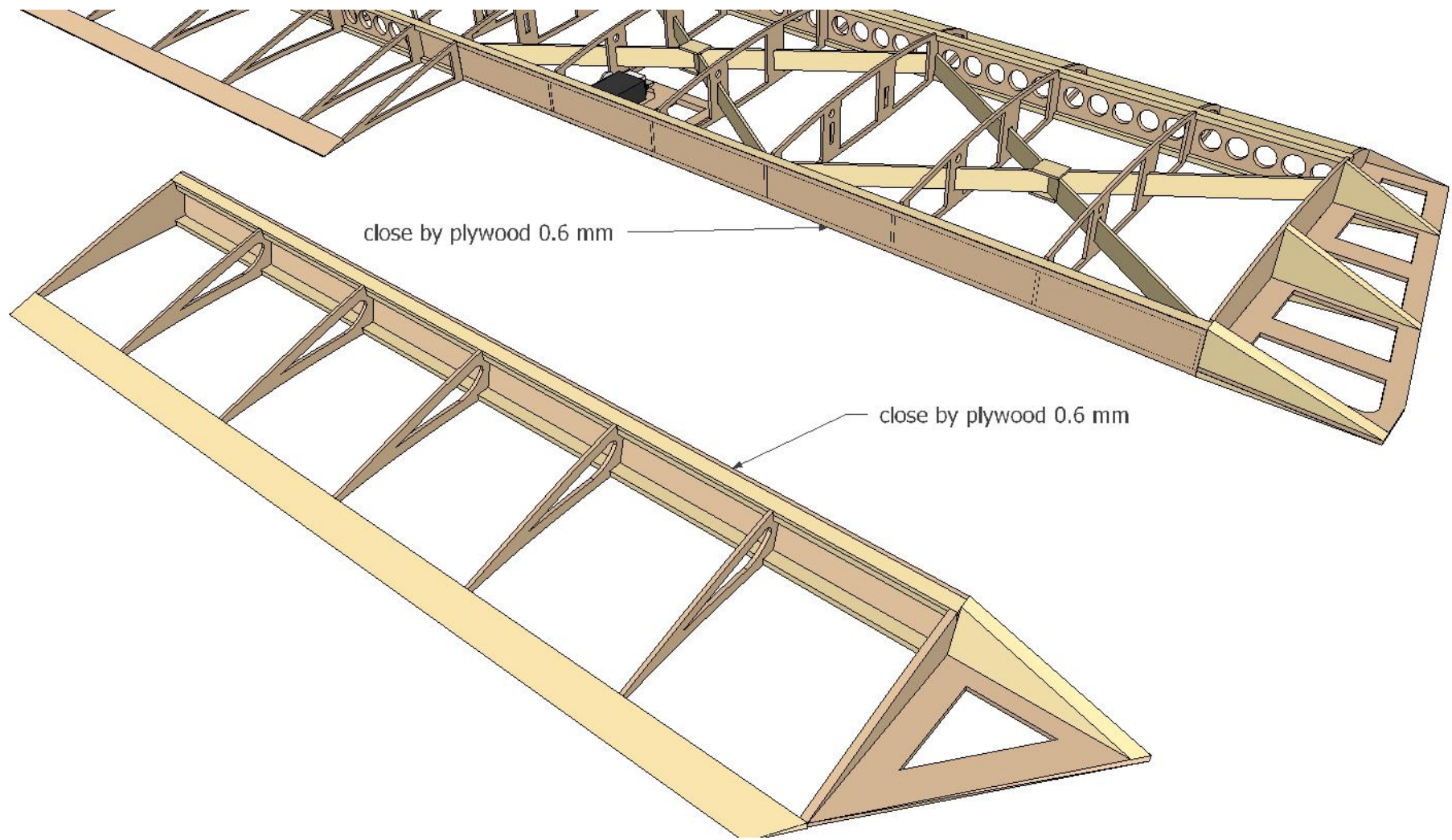

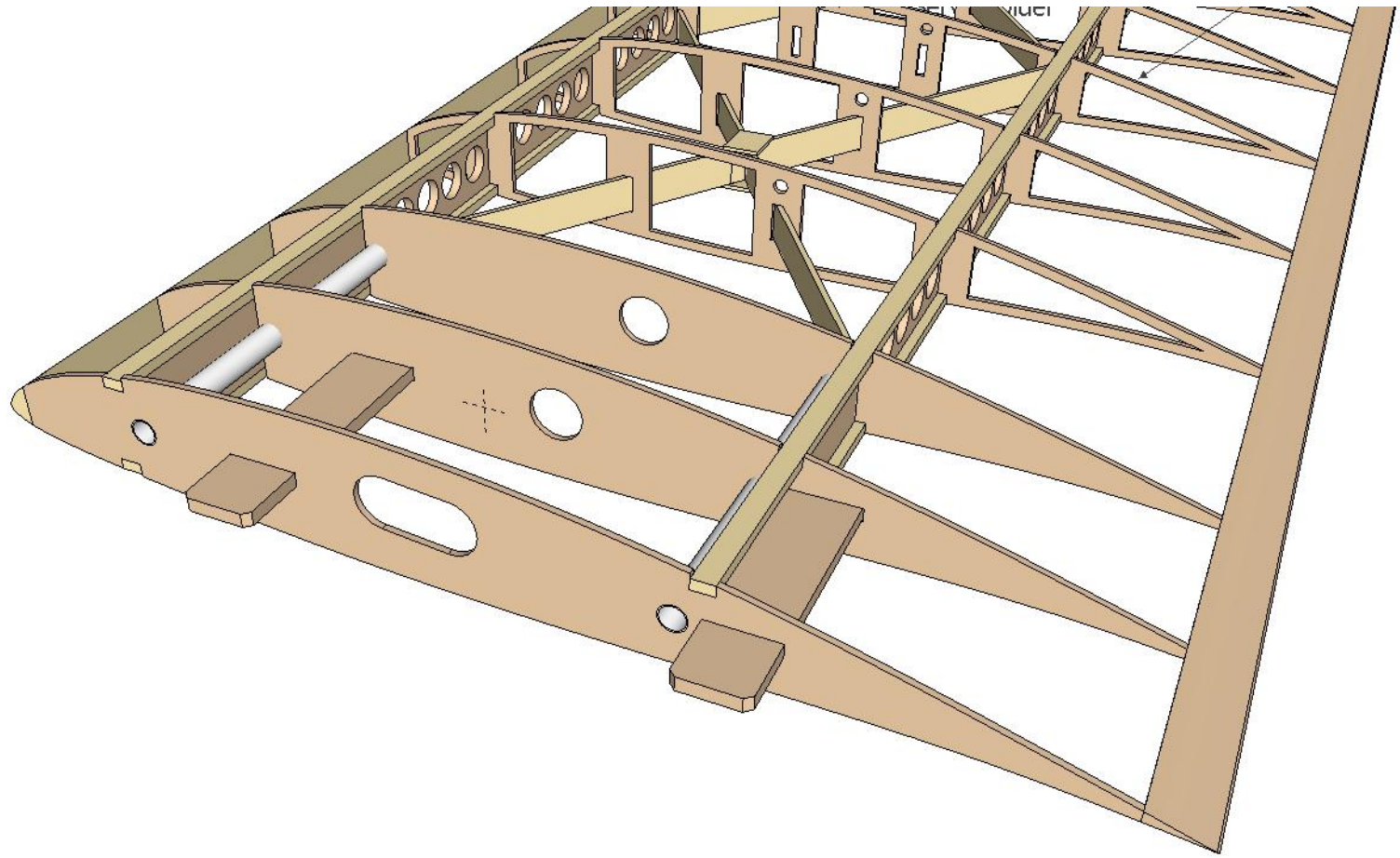

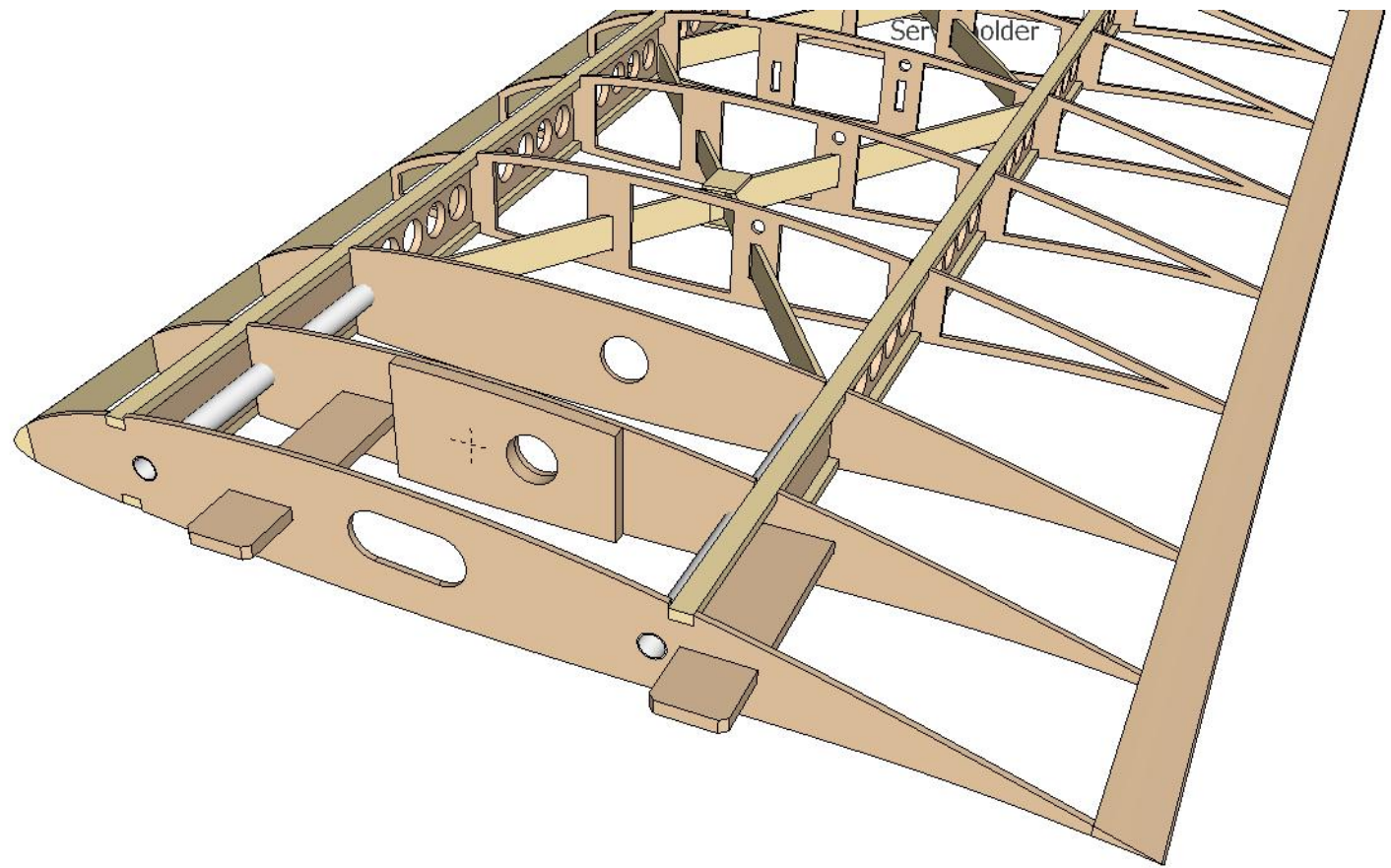



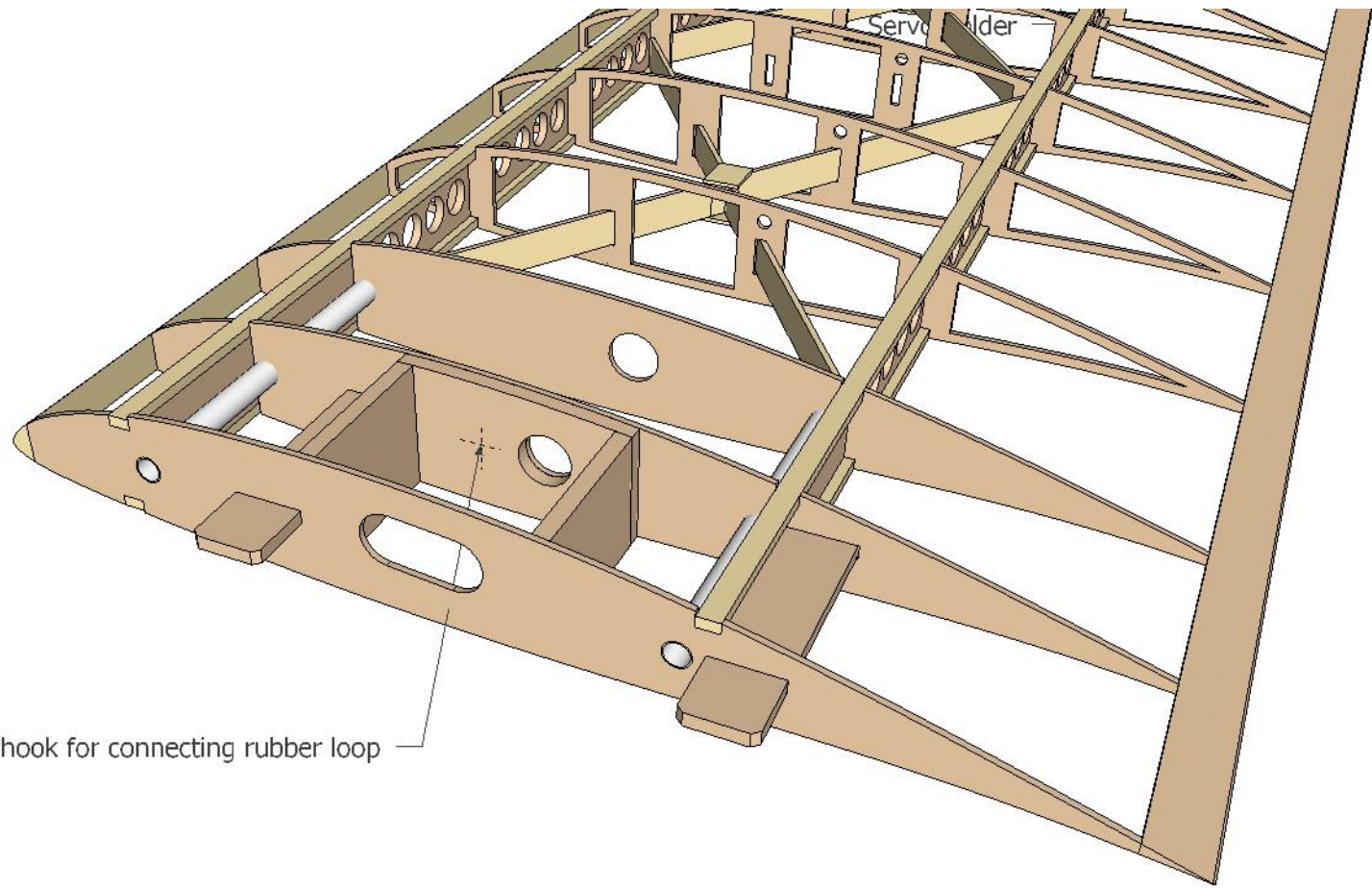

Burying the hook for connecting rubber loop

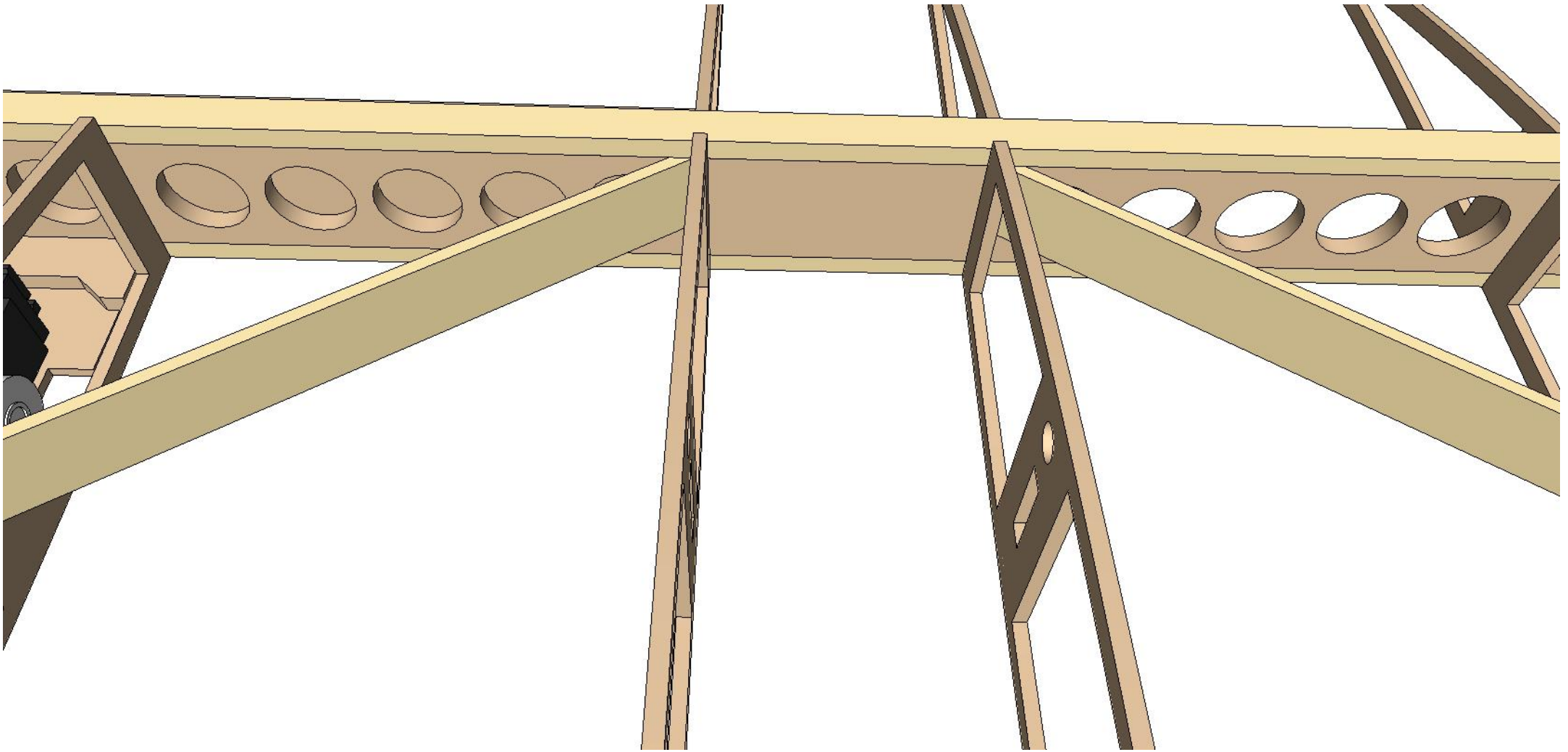

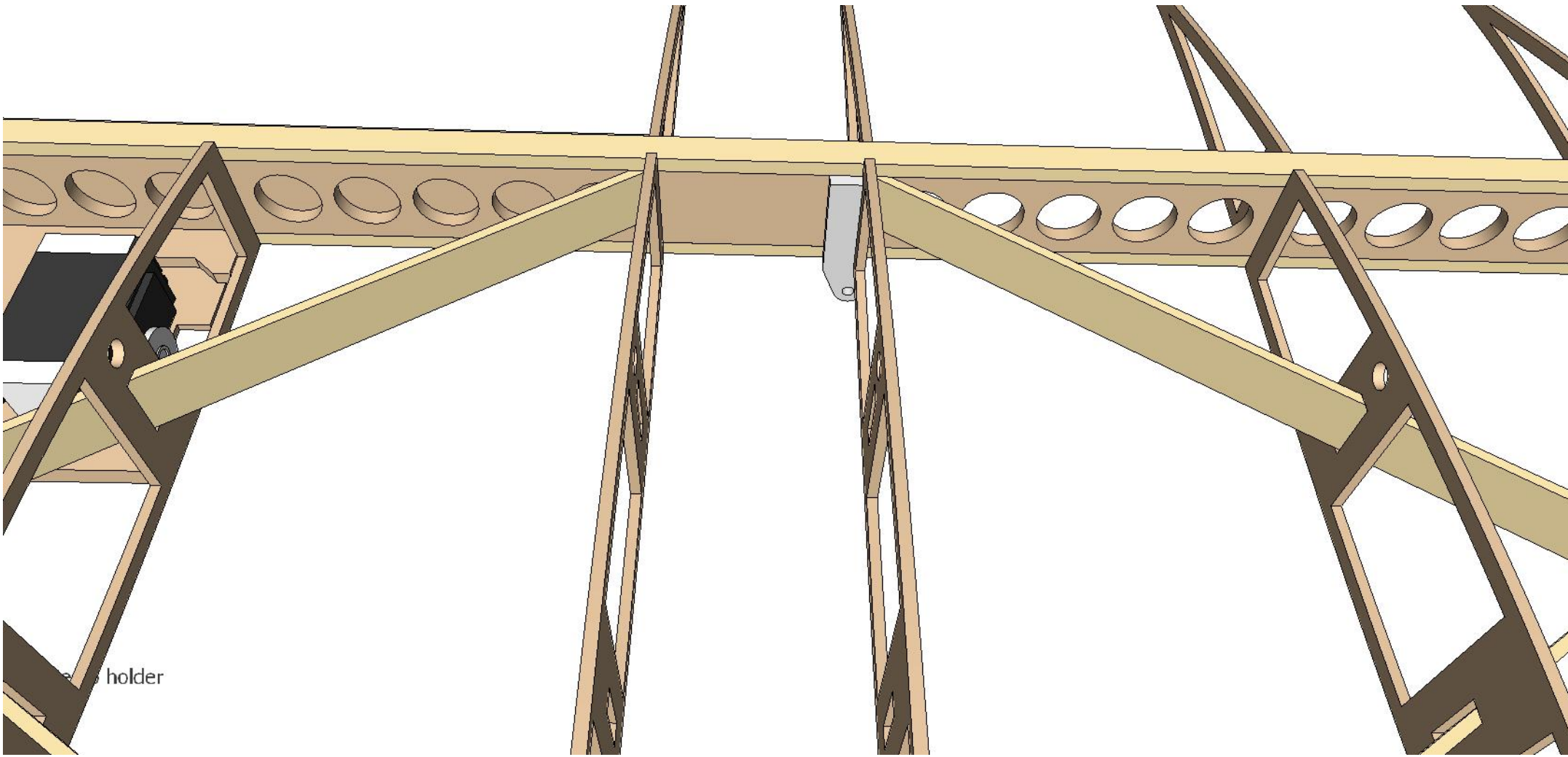

holder



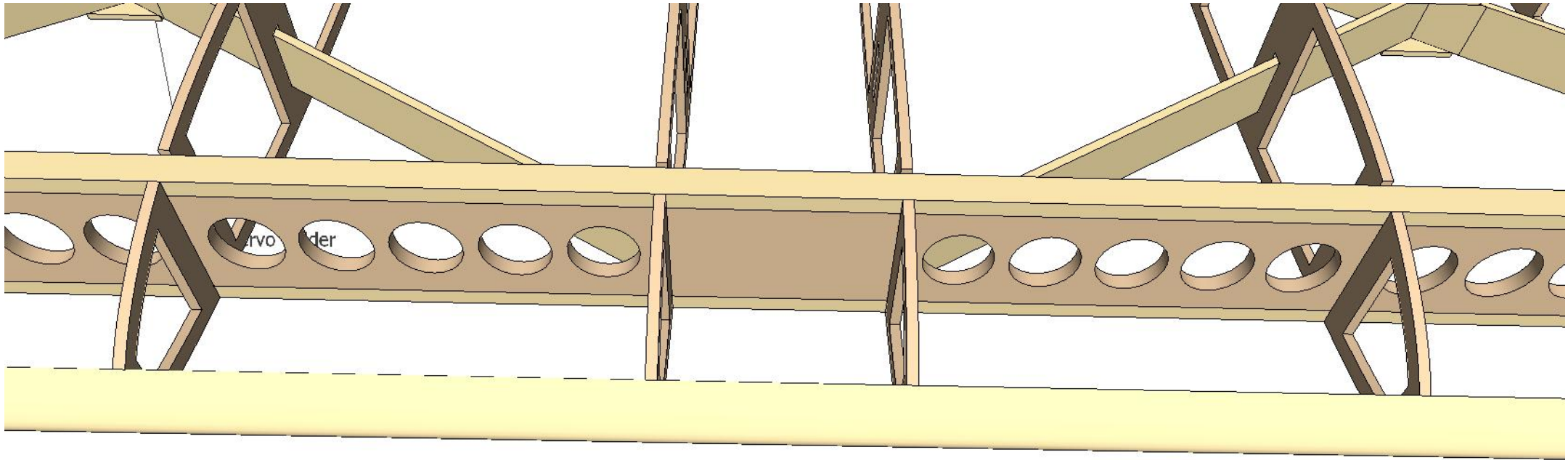

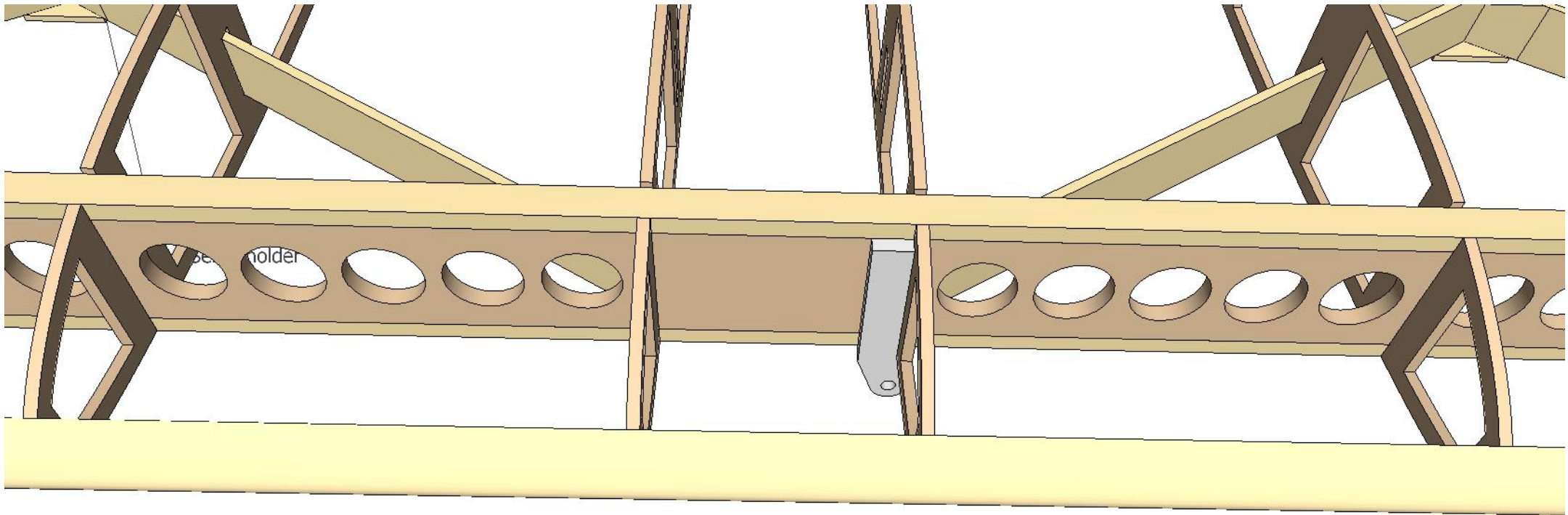

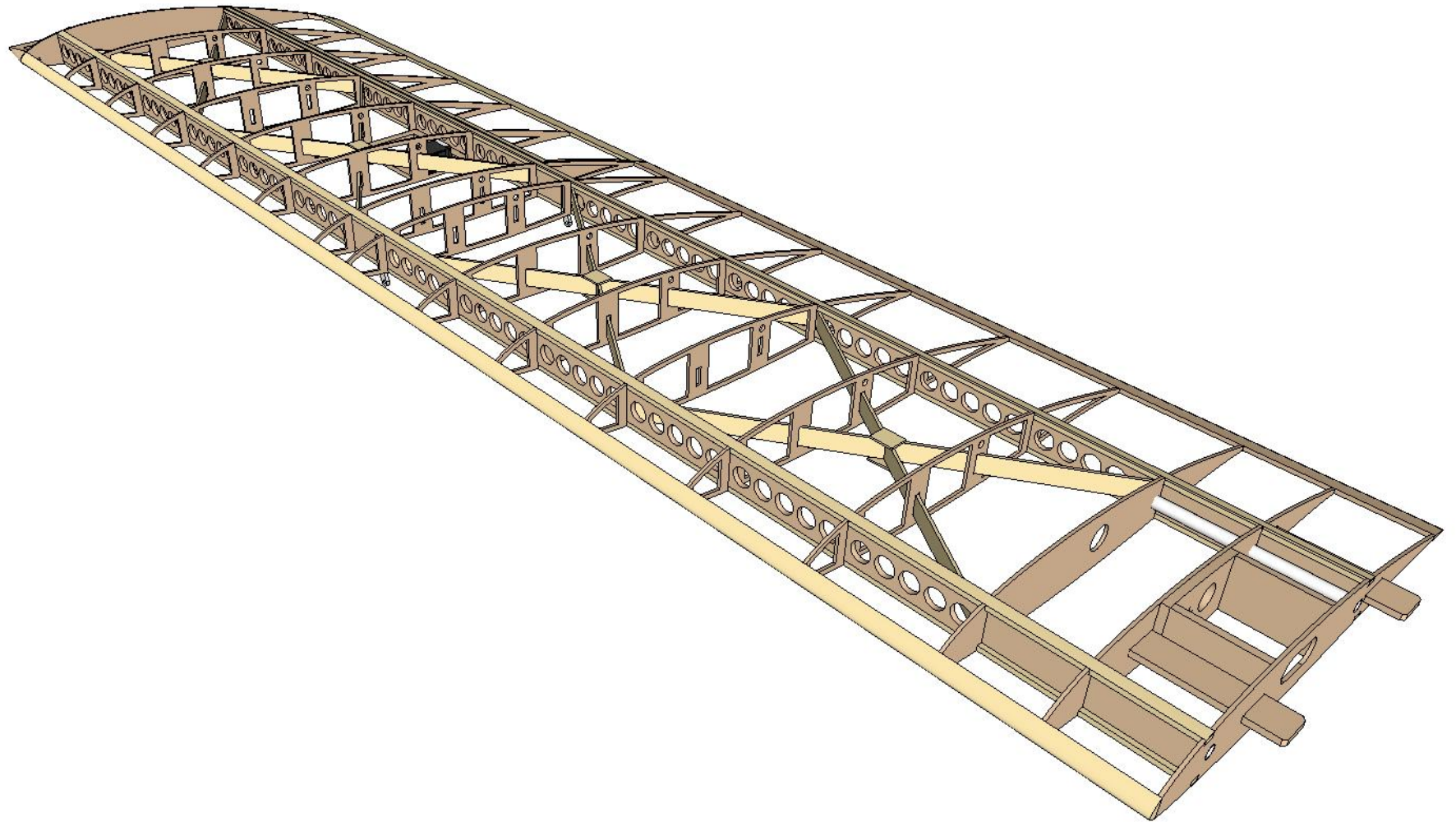



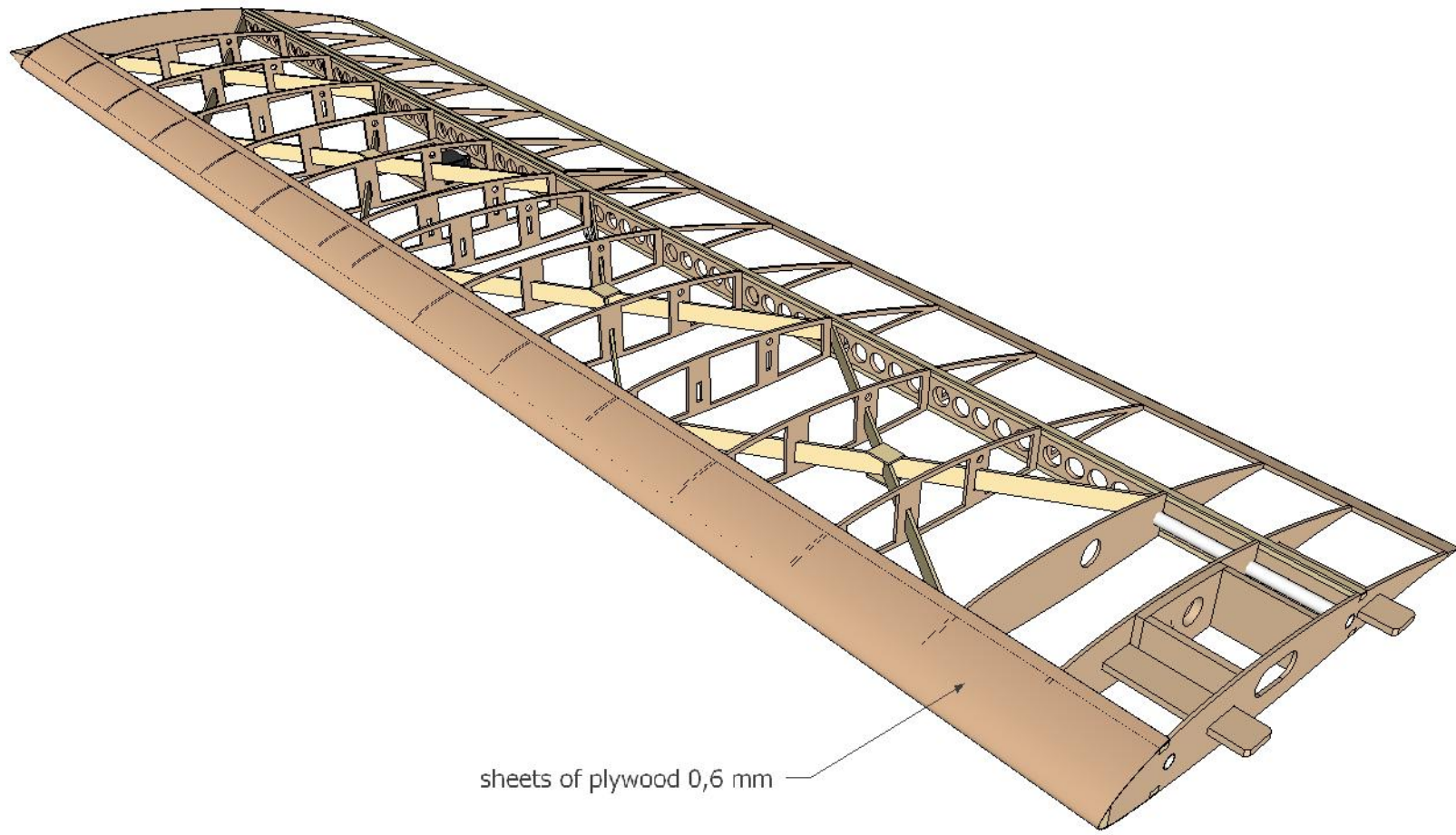

sheets of plywood 0,6 mm



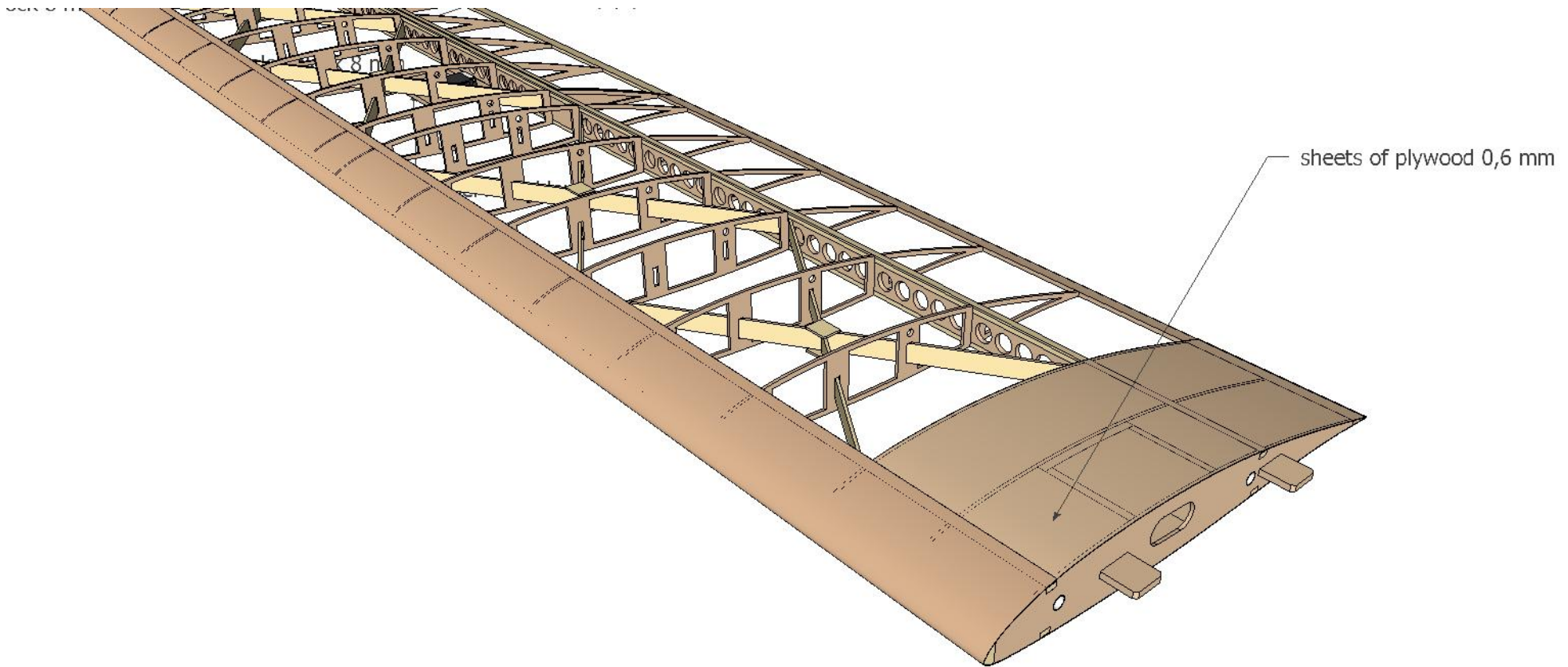

sheets of plywood 0,6 mm



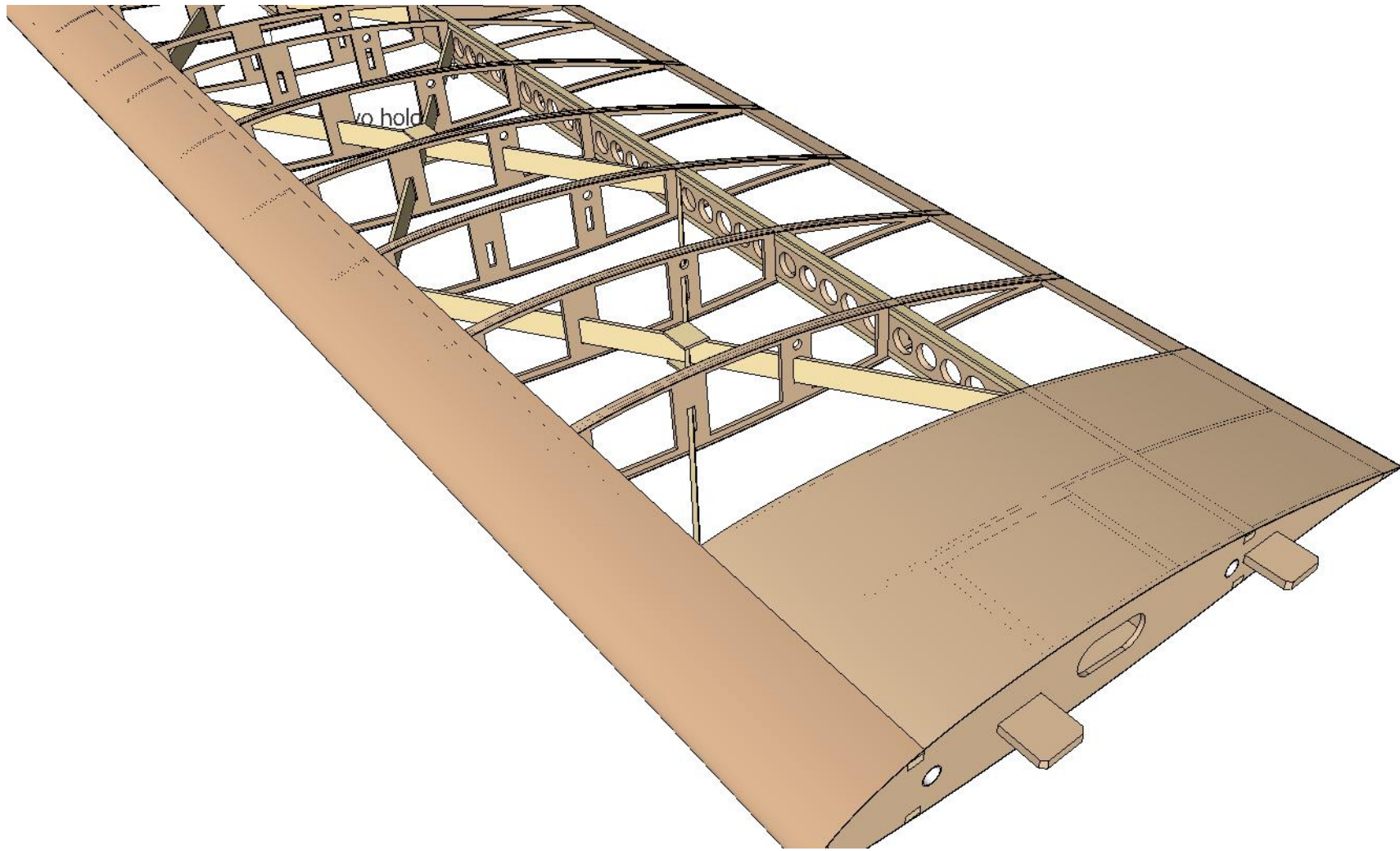

Balsa

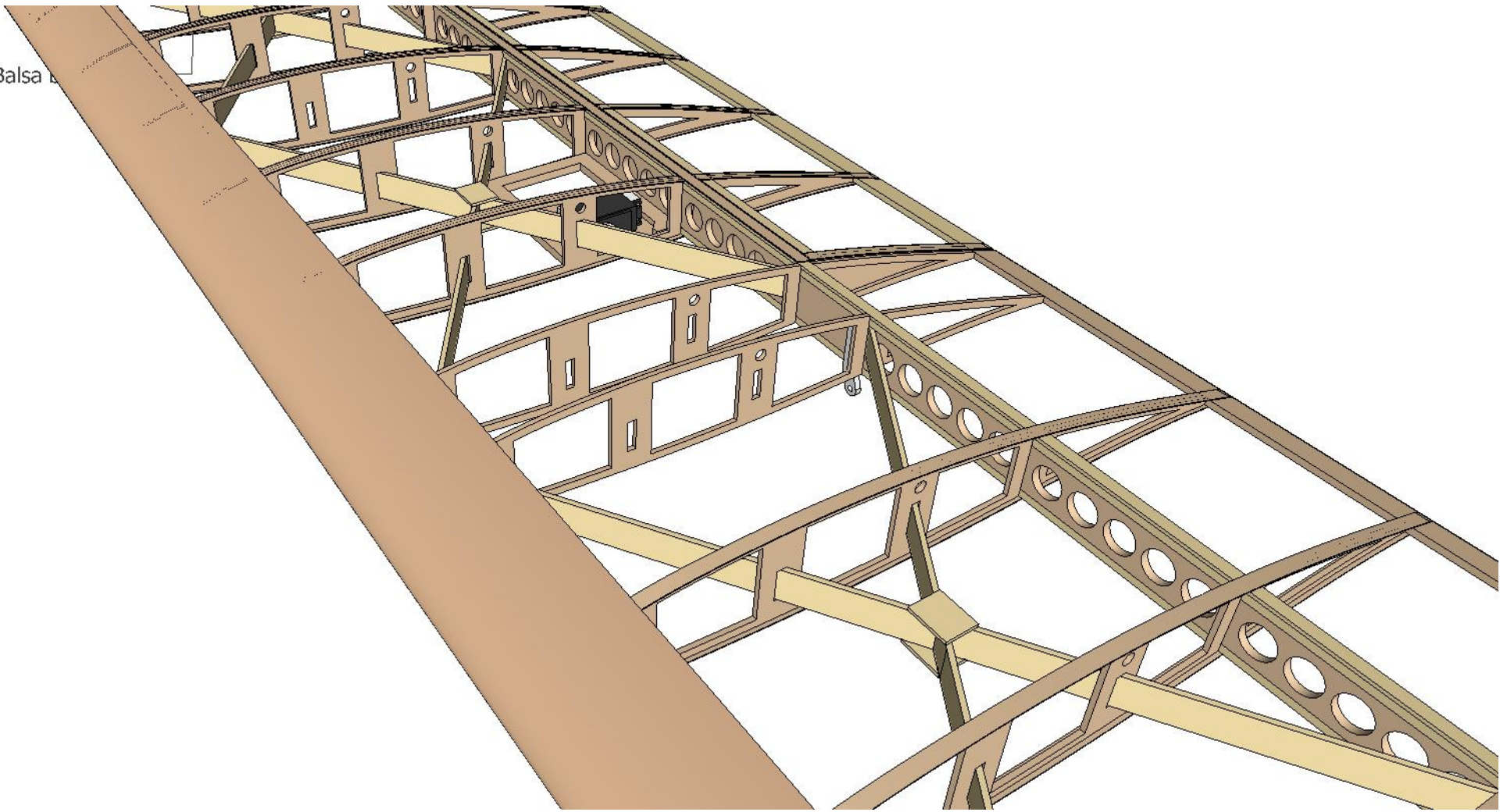

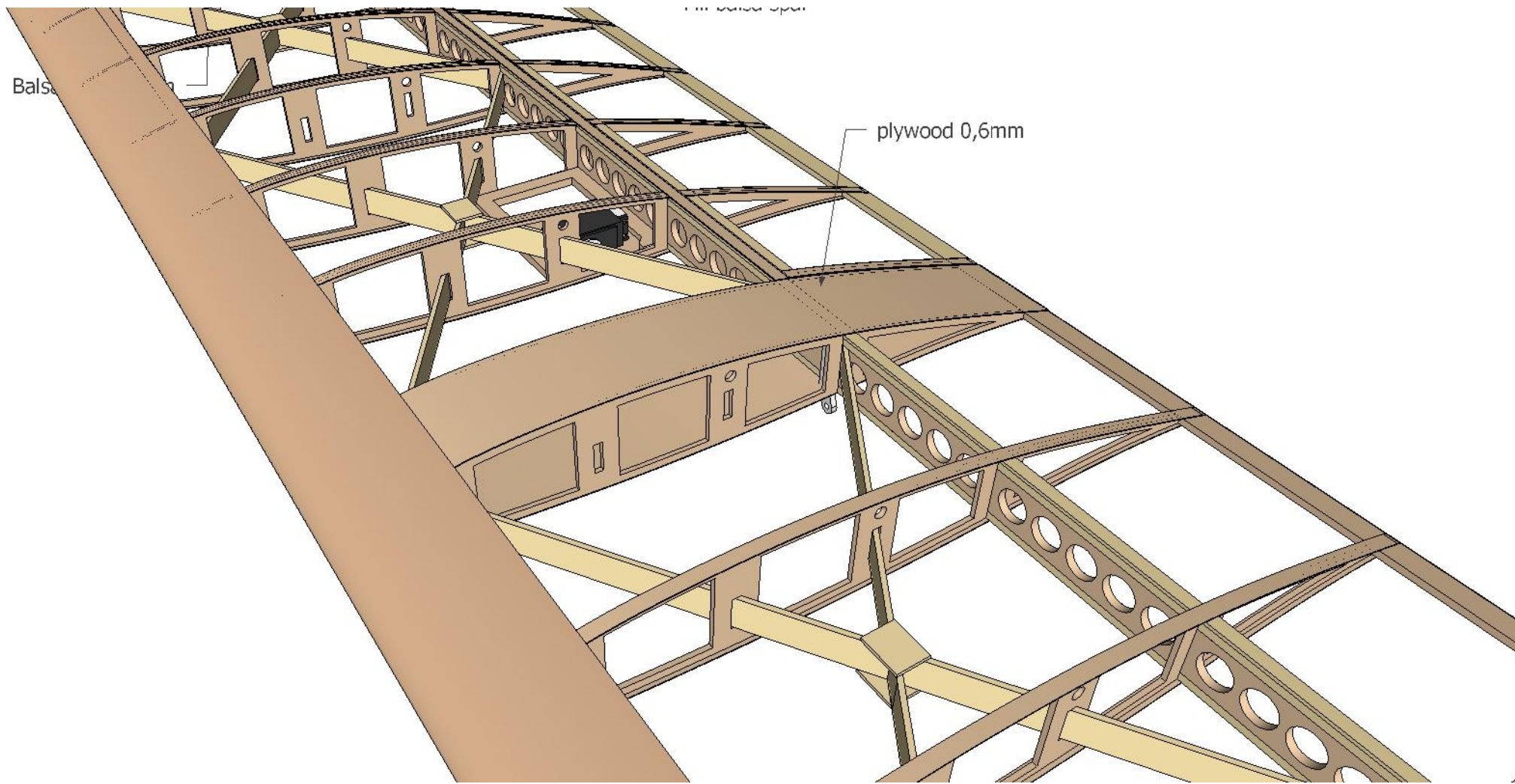

Balsa

1 m balsa spar

plywood 0,6mm



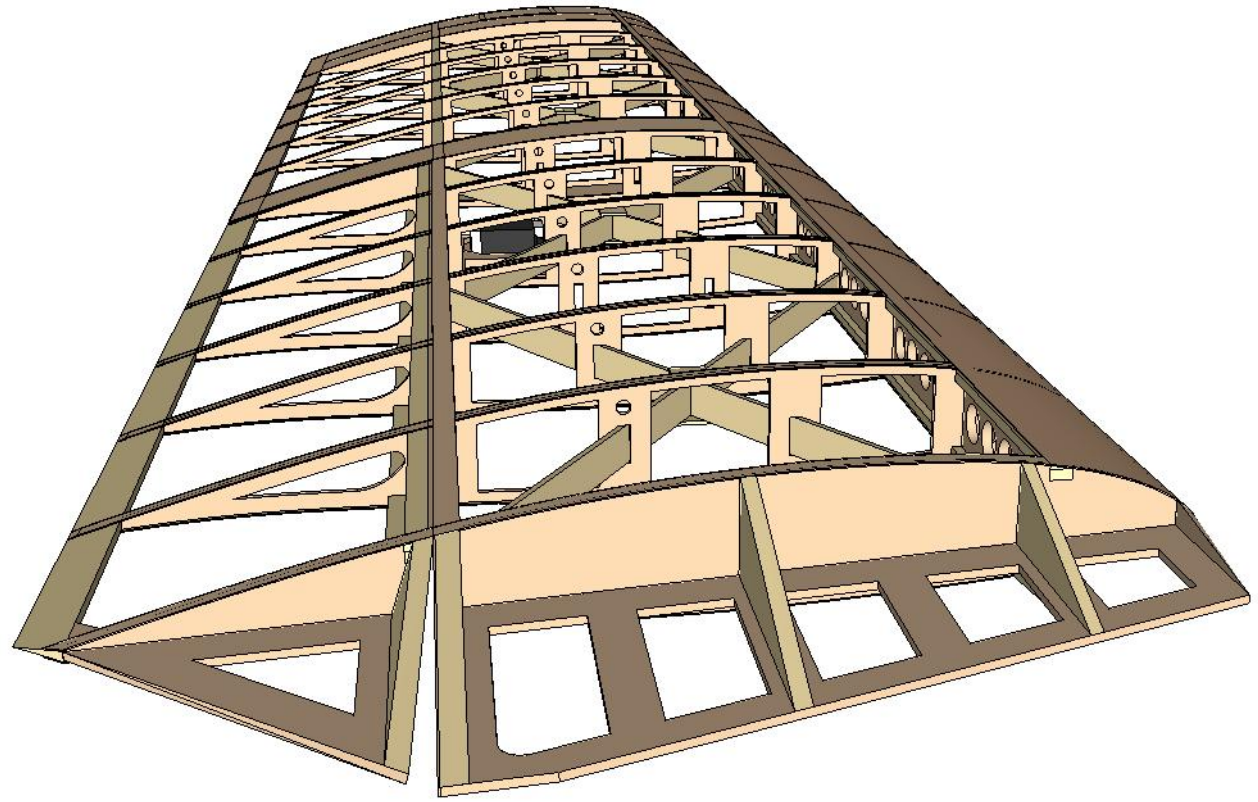

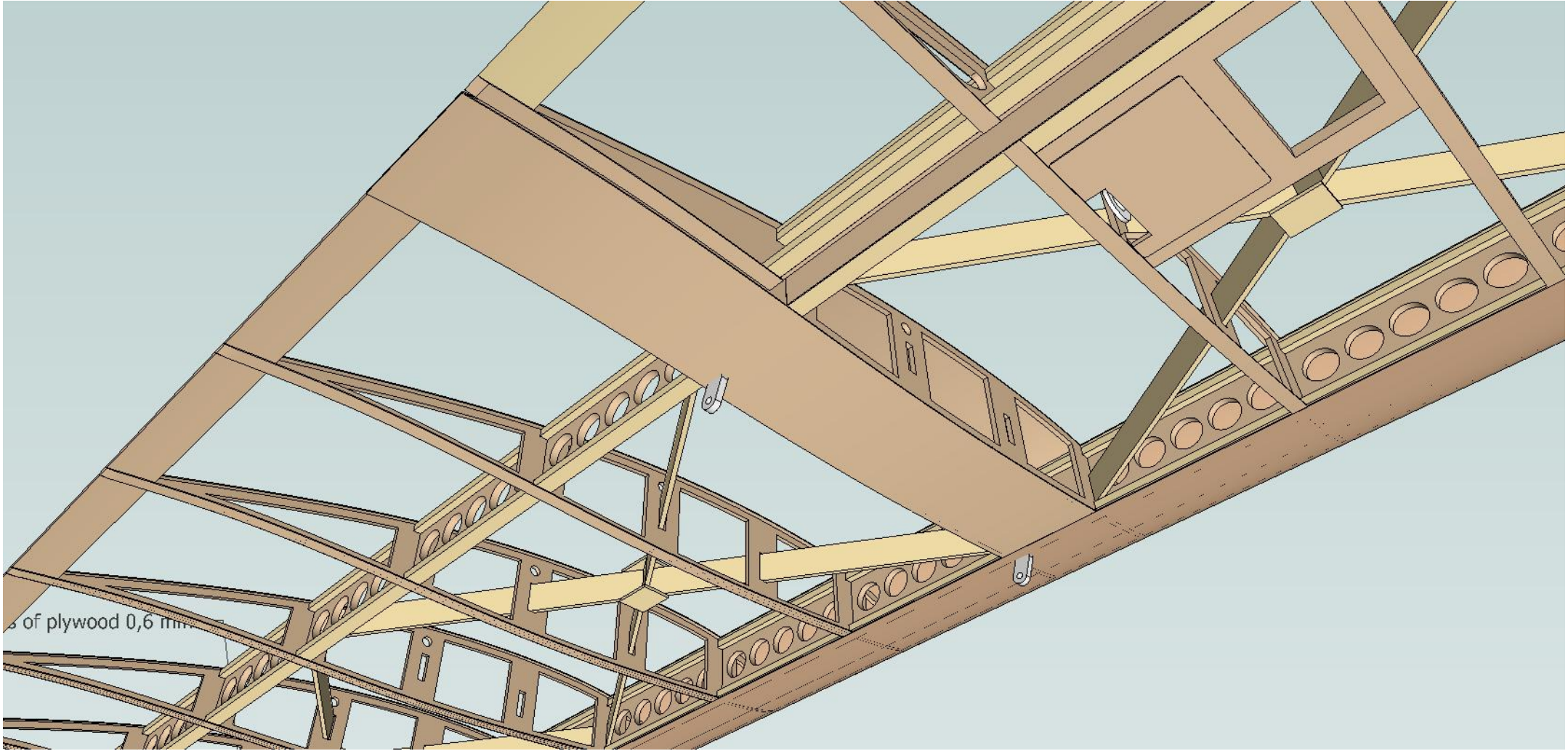

of plywood 0,6 mm